













































































**LOOK BEYOND
WHAT YOU SEE**

TWO THOUSAND
eighteen

19

DIGITAL SOLUTIONS

	CORNICI A SCATTO SNAPFRAME CLASSIC PROFILI 19, 25, 32, 44 mm.	da pag. 4		CORNICI A SCATTO SUPERIORMARKET FRAME	pag. 9		CORNICE DOPPIA PER VETRO WINDOWFRAME	pag. 10
	RESISTENTE ALL'ACQUA WATERPROOFFRAME	pag. 10		CORNICE A SOSPENSIONE DOUBLESIDED FRAME	pag. 11		CORNICE SLIDE IN SLIDEIN FRAME	pag. 11
	CORNICE CON CHIUSURA MAGNETICA MAGICFRAME	pag. 12		CORNICE PER PALO ROADSIGN FRAME	pag. 12		SOSTEGNO PER CORNICE A SCATTO CLING	pag. 12
	PROFILI PER CORNICI A SCATTO SNAPPROFILE	pag. 14		CORNICE LUMINOSA LED LIGHTLEDFRAME	pag. 15		CORNICE PER PLEXI E LED LEDPANELFRAME	pag. 15
	CORNICE ELEGANTE A GIORNO MUSEUMFRAME	pag. 16		SUPPORTO PER STAMPE POSTEREASY	pag. 17		PROFILI PORTA STAMPE SNAPPY CON RICAMBI	pag. 18/20
	PROFILI PORTA STAMPE POSTERFAST	pag. 21		BINARIO PORTA AVVISI FASTRAIL	pag. 21		CAVALLETTO ABOARD CLASSIC <small>PROFILO 32 mm</small>	pag. 22
	CAVALLETTO MONO ABOARD SINGLE SIDE <small>PROFILO 25 mm</small>	pag. 23		CAVALLETTI SCRIVIBILI BLACK/WHITE ABOARD <small>PROFILO 32 mm</small>	pag. 24		CAVALLETTO IN PLASTICA KING	pag. 25
	CAVALLETTO DA ESTERNO BASICSWING	pag. 26		CAVALLETTO DA ESTERNO SWINGER 3000	pag. 26		CAVALLETTO IN FERRO IRON ABOARD	pag. 27
	CAVALLETTO IN LEGNO WOOD ABOARD	pag. 28		BASI PER PANNELLI SWAPBASE PANELBASE	pag. 29		TOTEM TOOTHEM	pag. 30
	SEGNALETICA DIREZIONALE POINTER	pag. 32		CORNICI AUTOPORTANTI EASYPOLE	pag. 34		EASYPOLE S230 - STAND POKET - FIREMAN	pag. 35
	CORNICI AUTOPORTANTI EXHIBIT	pag. 37		COMPONENTI EASYPOLE	pag. 38		CROSSPOLE PRIME BANNER	pag. 39
	STRUTTURA ESPOSITIVA INFOSTAND	pag. 40		CORNICI AUTOPORTANTI ARKPOLE	pag. 42		ARKPOLE TRAVEL ESTATE	pag. 43
	STRUTTURA ESPOSITIVA BISIDESTAND	pag. 44		ARK iPOLE	pag. 45		ARKPOLE CRUISE SIGN	pag. 46
	ARKBANNER SPIDERPRO SPIDER	pag. 48		ZAINO PORTA BANNER BACKBACK BANNER	pag. 49		MINIX ROLLY - MINI ROLL UP PEG - PIEDE CARTONE	pag. 49
	ROLLUP BIFACCIALE ASTAFLAG TELESCOPICA	pag. 55		ASTEFLAG CLASSICHE XS - S - M - L - XL	pag. 56/57		ASTEFLAG RETTANGOLARI	pag. 58
	STREETFLAG WALLSTREETFLAG	pag. 61		STRUTTURA MODULARE BARRIER	pag. 62		STRUTTURE TELESCOPICHE FLAGWALL FLAGWALL extra	pag. 63
	POP WALL POP UP CURVO 3X3 BE POP BANCHETTO POP UP	pag. 65		PANEL DISPLAY PARETE ESPOSITIVA SMART BANCHETTO LEGGERO	pag. 66		BANCHETTI ESPOSITIVI PROMOTABLE FABRIC TABLE	pag. 67
	SEGNALETICA INTERNA DI SICUREZZA			TARGHE CON PROFILO A SCATTO SNAPSIGN	pag. 69		TARGHETTE SEGNALETICHE 10X10 SQUARESIGN	pag. 69
	SEGNALETICA INTERNA A BANDIERA FLAG ALUSIGN	pag. 71		SEGNALETICA INTERNA A SOSPENSIONE SUSPENSION ALUSIGN	pag. 71		SEGNALETICA INTERNA DA PARETE ALUSIGN	pag. 70
	WOOD DISPLAYS			CAVALLETTO LAVAGNA WOOD ABOARD	pag. 73		LAVAGNA DA BANCO WOODEN TABLE TOP	pag. 73
	LAVAGNA HANG	pag. 74		CAVALLETTO IN LEGNO WOODEN EASEL	pag. 74		BARRE PER TELAIO IN LEGNO WOODEN FRAME BARS	pag. 74
	PORTADEPLIANT SU PALO FLOOR	pag. 76		PORTADEPLIANT SU PALO STORE	pag. 76		PORTADEPLIANT PIEGHEVOLI FOLDABLE FAST	pag. 77
	LEGGIO READING	pag. 78		ESPOSITORE PORTADEPLIANT EASYPOLE S230	pag. 79		BANCHETTO PIEGHEVOLE BROCHURE TABLE	pag. 79
	DISTANZIALI IN ALLUMINIO ALUMINIUM STANDOFFS	pag. 81		DISTANZIALI DOPPI ALU DOUBLE	pag. 82		DISTANZIALI MAGNUM ALU MAGNUM	pag. 83
	DISTANZIALI IN ACCIAIO STEEL STANDOFFS	pag. 84		DISTANZIALI IN OTTONE ARK BRASS	pag. 85		DISTANZIALI ORO LUCIDO FIX SERIES DISTANZIALI VUOTI EMPTY SERIES	pag. 86

 DISTANZIALI A PRESSIONE KLIKWALL TARGHE IN ACRILICO TRASPARENTE PLATE	pag. 88 pag. 92/93	 COPRIVITE DOT PROFILI PORTA TARGHE ALURAIL	pag. 89 pag. 94	 DISTANZIALI SPECIALI ENSIGN - A BANDIERA SIDE - LATERALE	pag. 90 pag. 95	 DISTANZIALI SPECIALI ALU4WAYS - 4 VIE ROLLING - A ROTAZIONE BULLET - SOSTEGNO TARGHE	pag. 91		
SIGN & TOTEM		 INSEGNE LUMINOSE BIFACCIALI LIGHTED SIGN	pag. 97	 CROCI LED FARMACIA PHARMACY CROSS	pag. 98	 CASSONETTO LUMINOSO LIGHTED BOX	pag. 98		
LED LIGHTS		 TOTEM BIFACCIALI DANDY SLIM	pag. 99	 SCATOLATO IN PLEXI PLEXI CASE	pag. 100	 INSEGNE FAST FOOD EMBLEM	pag. 100		
	 MINIMODULI LED STRIPLLED + ACCESSORI	pag. 102	 PROFILI PER LUCI LED LED PROFILE	pag. 103/104	 TARGHE SU PROFILO CON LED LIGHTED PLATES	pag. 105		pag. 106	
	 TARGA LUMINOSA LED PLEXI LED	pag. 105	 CORNICE LUMINOSA LED LIGHTLED FRAME	pag. 106	 TIRANTE SUPERIORE FLAT	pag. 108		pag. 108	
SUSPENSION SYSTEM - MAGIC		 TIRANTE SUPERIORE FLAT	pag. 108	 TIRANTE INFERIORE UNDER	pag. 108	 TIRANTE SUPERIORE FISSO MAGIC	pag. 108		pag. 109
	 TIRANTE INFERIORE FISSO PULLS	pag. 108	 CONTRAPPESO INFERIORE SINKER	pag. 109	 MORSETTO PORTA PANNELLI CLOUD	pag. 109		pag. 109	
	 FERMACAVO GLOBE WIRE	pag. 109	 PINZE PER TASCHE TONG - SINGOLA TONGDOUBLE - DOPPIA	pag. 110	 TASCHE PER SISTEMA MAGIC POKET	pag. 110		pag. 111	
	 SISTEMA A CAVO SU PALI PER TASCHE POLEMAGIC	pag. 112	 PINZE PER RIPIANI SHEL - SINGOLA SHELDDOUBLE - DOPPIA	pag. 113	 RIPIANO IN ACRILICO SHELF	pag. 113		pag. 114	
OSDISPLAYS		 BACHECA A GIORNO IN SUGHERO CORK OFFICE BOARD	pag. 116	 BACHECA A GIORNO MAGNETICA MAGNETIC OFFICE BOARD	pag. 116	 BACHECA IN SUGHERO CON ANTA CORK SHOW BOARD	pag. 117		pag. 118
	 BACHECA MAGNETICA CON ANTA MAGNETIC SHOW BOARD	pag. 117	 PORTABIGLIETTI DA VISITA BUSINESS CARD HOLDER	pag. 118	 PORTADEPLIANT DA BANCO BROCHURE HOLDER A5	pag. 120		pag. 121	
	 PORTADEPLIANT DA BANCO BROCHURE HOLDER A5	pag. 120	 PORTADEPLIANT DA BANCO BROCHURE HOLDER A4	pag. 121	 PORTADEPLIANT DA PARETE BROCHURE HOLDER WALL MOUNTING	pag. 122		pag. 123	
	 PORTA AVVISI INCLINATI LEAFLET HOLDER ANGLED	pag. 124	 PORTA AVVISI INCLINATI PRICE	pag. 125	 PORTA AVVISI INCLINATO MAGNETICO ALUPRICE	pag. 126		pag. 126	
	PORTA AVVISI BIFACCIALI DESK LABEL	pag. 127	PORTA AVVISI MULTIPLO MULTIPLE	pag. 128	PORTA AVVISI TRIFACCIALE PRISMA	pag. 128		pag. 129	
	PORTA AVVISI TRASPARENTI POSTER FIX	pag. 129	ESPOSITORE SMARTPHONE PHONEHOLDER POS	pag. 130	ESPOSITORE SMARTPHONE PHONEHOLDER BIG	pag. 130		pag. 131	
	CASSETTINA SUGGERIMENTI SUGGESTION BOX	pag. 131	CASSETTINE PORTACHIAVI KEYS BOX	pag. 131	PORTAPREZZI CON CLIP PRICE CLIP	pag. 132		pag. 132	
	PORTA BIGLIETTI TASCABILE IN ALUMINIO ALUBCHOLDER	pag. 132	ROADSIGN	TABELLE STRADALI CLASSICHE	pag. 133	TABELLE STRADALI SAGOMATE	pag. 133		pag. 133
	PALO ZINCATO 3 mt. x Ø. 60 cm.	pag. 133	STAFFE PER PALO MONOFACCIALE BIFACCIALE	pag. 133	BASE MOBILE PER PALI Ø. 60 cm.	pag. 133		pag. 136	
ACCESSORIES & TOOLS		PORTA NOME HELLO	pag. 135	PORTA BADGE WHOAREYOU STRING	pag. 135	ARROTONDA ANGOLI PROFESSIONAL MANUALE	pag. 138		pag. 139
	OCCHIELLATRICI PROFESSIONAL SEMI AUTO MANUALE	pag. 137	UTENSILI TOOLS FERMAROTOLO, TENDITELO, OCCHIELLI, MAGNETI ...	pag. 141	FASCE ELASTICHE VELCRO ADESIVO	pag. 142		pag. 140	
	UTENSILI SPATOLE VARIE TIPOLOGIE E MISURE	pag. 140							

DIGITAL SOLUTIONS



Soluzioni espositive per il mondo della stampa digitale, piccolo e grande formato.



Clever and stylish applications for the professional digital printing.



CORNICI A SCATTO | SNAPFRAME klikclak



CORNICI A SCATTO

Le cornici a scatto sono un ottimo mezzo di comunicazione di facile utilizzo. Disponibili in più formati e diverse versioni.

- Realizzate in Alluminio
- Protezione in PVC Antiriflesso
- Fondo in Plastica
- Profili disponibili: 19, 25, 32 e 44 mm.
- Disponibili con Agolo tondo e vivo
- Imballati Singolarmente
- Viti e Tasselli inclusi
- Disponibili in diversi formati

- Made of Aluminium
- Antireflection PVC cover
- Plastic back panel
- Profile: 19, 25, 32 and 44 mm.
- Round and Mitred Corner
- Single Packed
- Screws included
- Many sizes available



CLICKCLACK



PROTEZIONE PVC





PROFILO 19mm.

CORNICI A SCATTO | SNAPFRAME

19 mm | klikclak

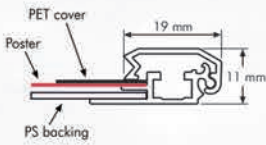
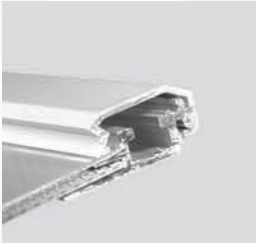

Utilizzo sia in Orizzontale che in Verticale
Use portrait or landscape

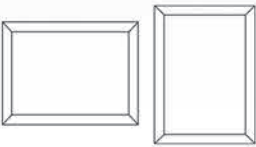

- Protezione in PVC Antiriflesso
- Imballati Singolarmente
- Viti e Tasselli inclusi
- Antireflection PVC cover
- Single Packed
- Screws included

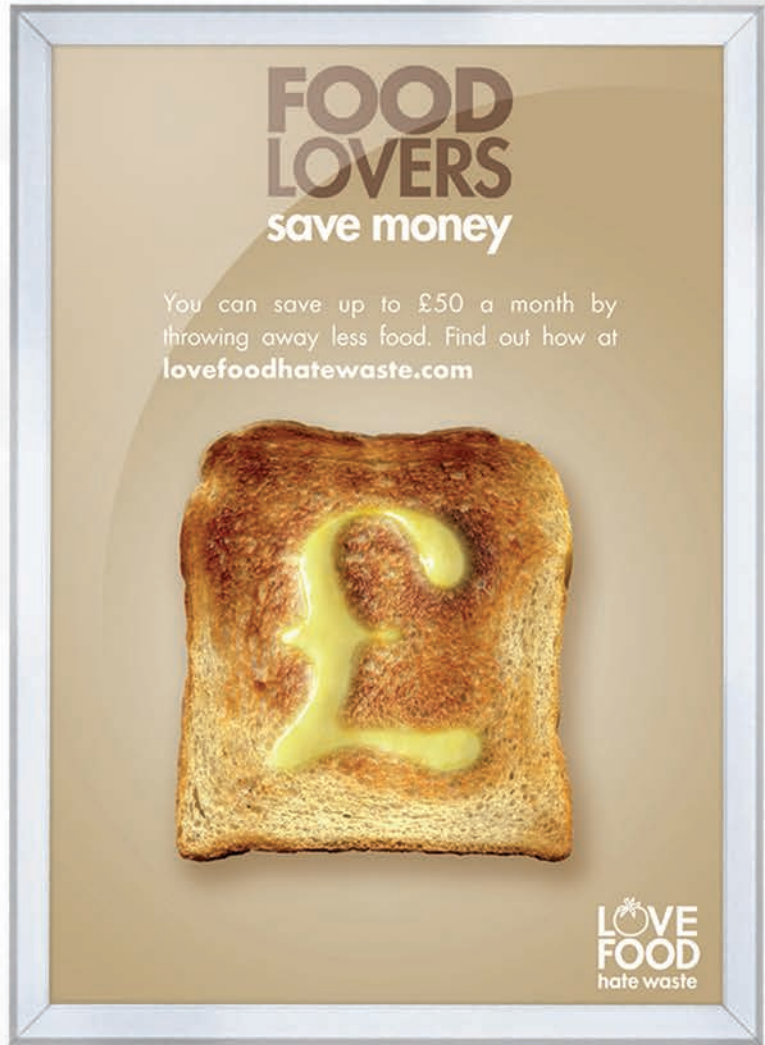

MITRED CORNER



ANGOLO VIVO	Size	Profile	Poster	External	Copy	Weight	Box	PLT
cod. 100531	A5	19mm	cm 14,8x21	cm 17,8x24	cm 14x20	Kg 0,2 ca.	10	900
cod. 100532	A4	19mm	cm 21x29,7	cm 24x32,7	cm 20x29	Kg 0,4 ca.	10	600
cod. 100533	A3	19mm	cm 29,7x42	cm 32,7x45	cm 29x41	Kg 0,7 ca.	10	280
cod. 100537	B2	19mm	cm 50x70	cm 53x73	cm 49x69	Kg 1,2 ca.	10	150
cod. 100538	B1	19mm	cm 70x100	cm 73x103	cm 69x99	Kg 2,3 ca.	10	70



PROFILO 25mm.

CORNICI A SCATTO | SNAPFRAME

25 mm | klikclak

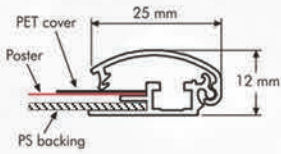

Utilizzo sia in Orizzontale che in Verticale
Use portrait or landscape

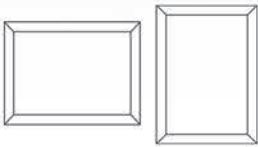

- Protezione in PVC Antiriflesso
- Imballati Singolarmente
- Viti e Tasselli inclusi
- Antireflection PVC cover
- Single Packed
- Screws included



MITRED CORNER

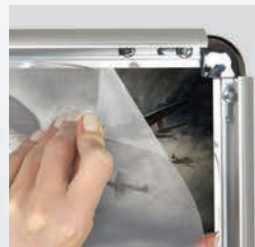
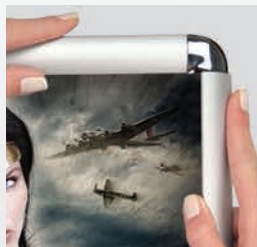

ROUND CORNER



ANGOLO VIVO		Size	Profile	Poster	External	Copy	Weight	Box	PLT	ANGOLO TONDO	
cod.	100010	A4	25mm	cm 21x29,7	cm 24x32,7	cm 19,2x27,9	Kg 0,5 ca.	10	600	cod.	100001
cod.	100011	A3	25mm	cm 42x29,7	cm 45x32,7	cm 40,2x27,9	Kg 0,8 ca.	10	280	cod.	100002
cod.	100549	A2	25mm	cm 42x59,4	cm 45x62,4	cm 40x57,4	Kg 1,2 ca.	10	150		
cod.	100550	A1	25mm	cm 59,4x84	cm 62,4x87	cm 57,4x82	Kg 1,9 ca.	10	100		
cod.	100551	A0	25mm	cm 84x118,9	cm 87x121,3	cm 82x116,9	Kg 3,4 ca.	5	30	cod.	100003
cod.	100012	B2	25mm	cm 50x70	cm 53x73	cm 48,2x68,2	Kg 1,3 ca.	10	150	cod.	100544
cod.	100552	B1	25mm	cm 70x100	cm 73x103	cm 68x98	Kg 2,6 ca.	10	70	cod.	100545
cod.	100553	*	B0	cm 100x140	cm 103x143	cm 98x138	Kg 5,1 ca.	10	35		*

*Costi di imballaggio per cornici 100x140 cm.

*Packing cost for snap frames 100x140 cm.

cod. 100020 ~ PACKING COST *



PROFILO 32mm.

CORNICI A SCATTO | SNAPFRAME

32 mm | klikclak

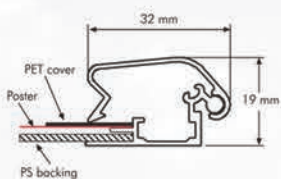

Utilizzo sia in Orizzontale che in Verticale
Use portrait or landscape

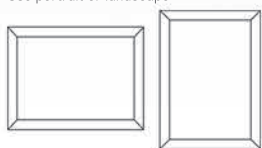

- Protezione in PVC Antiriflesso
- Imballati Singolarmente
- Viti e Tasselli inclusi
- Antireflection PVC cover
- Single Packed
- Screws included



MITRED CORNER

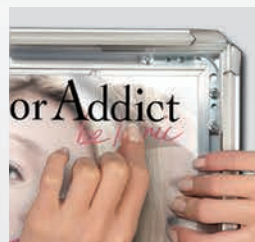

ROUND CORNER



ANGOLO VIVO		Size	Profile	Poster	External	Copy	Weight	Box	PLT	ANGOLO TONDO	
cod. 100013		B1	32mm	cm 70x100	cm 74,3x104,3	cm 68x98	Kg 3,3 ca.	5	70	cod. 100004	
cod. 100014	*	B0	32mm	cm 100x140	cm 104,3x144,3	cm 98x138	Kg 6,1 ca.	5	35	cod. 100005	*

*Costi di imballaggio per cornici 100x140 cm.
*Packing cost for snap frames 100x140 cm.
cod. 100020 ~ PACKING COST *



PROFILO 44mm.

CORNICI A SCATTO | SNAPFRAME 44mm | klikclak

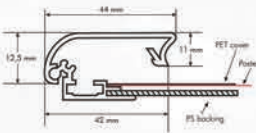
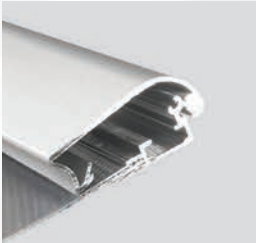

Utilizzo sia in Orizzontale che in Verticale
Use portrait or landscape

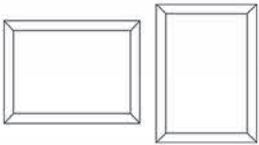

- Protezione in PVC Antiriflesso
- Imballati Singolarmente
- Viti e Tasselli inclusi
- Antireflection PVC cover
- Single Packed
- Screws included

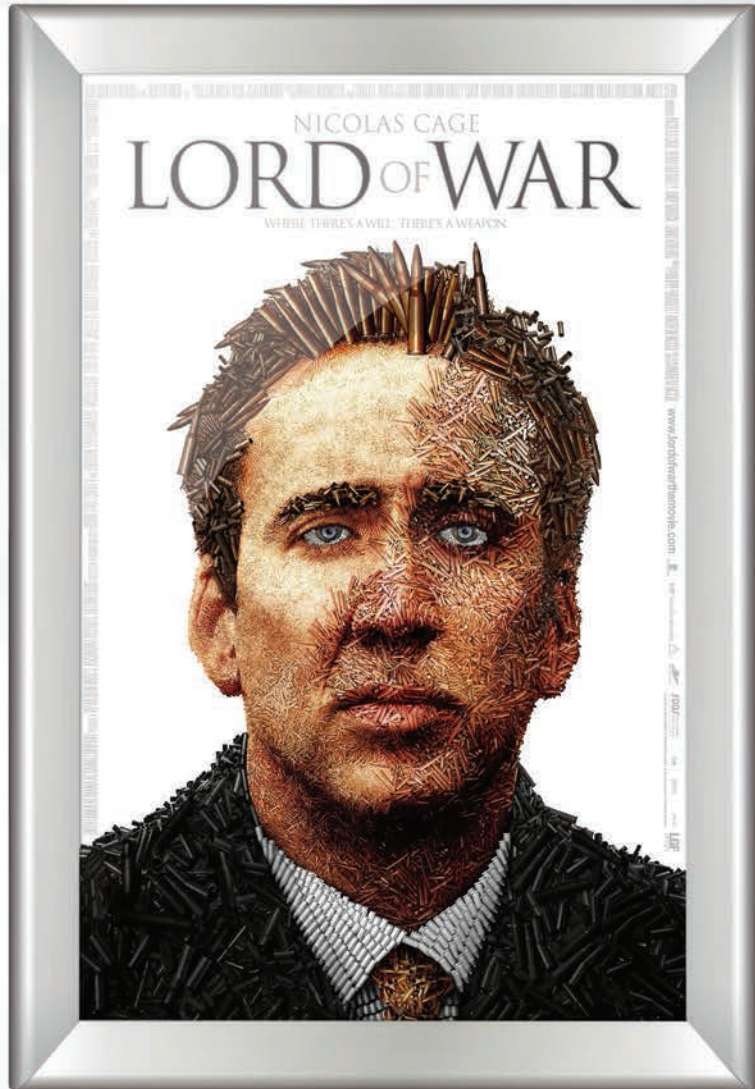

MITRED CORNER



ANGOLO VIVO	Size	Profile	Poster	External	Copy	Weight	Box	PLT
cod. 100576	B1	44 mm	cm 70x100	cm 74,3x104,3	cm 68x98	Kg 3,4 ca.	5	70
cod. 100577 *	B0	44 mm	cm 100x140	cm 104,3x144,3	cm 98x138	Kg 6,7 ca.	5	35

*Costi di imballaggio per cornici 100x140 cm.
*Packing cost for snap frames 100x140 cm.

cod. 100020 ~ PACKING COST *



STRONG!

SUPERIOR MARKET FRAME

Cornice a scatto superiore, rinforzata. Realizzata in alluminio con fondo in lamiera e protezione in PVC da 2 mm. Disponibile nei formati 70x100 e 100x140 cm. con profilo da 32 e 44 mm. Ideali per supermercati, centri commerciali, stazioni, aeroporti e luoghi pubblici in genere.

- Profilo 32 e 44 mm.
 - Fondo in lamiera metallica
 - Protezione in PVC spessa 2 mm.
 - Angolo Tondo o Angolo Vivo
 - Disponibile 70x100 e 100x140 cm.
 - Imballati Singolarmente
 - Viti e Tasselli inclusi
- Profile 32 and 44 mm.
 - Iron back panel
 - Pvc cover thickness 2 mm.
 - Round or Mitred Corner
 - Available 70x100 and 100x140 cm.
 - Single Packed
 - Screws included



PROFILO 32 mm

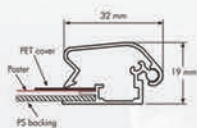

PROFILO 44 mm

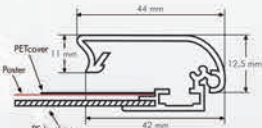

FONDO IN LAMIERA



PROTEZIONE PVC 2 mm

MITRED CORNER



PROFILO 32 mm.

cod. 100578 ~ B1 cm 70x100

cod. 100579 ~ B0 cm 100x140 *

PROFILO 44 mm.

cod. 100580 ~ B1 cm 70x100

cod. 100581 ~ B0 cm 100x140 *

ROUND CORNER



PROFILO 32 mm.

cod. 100582 ~ B1 cm 70x100

cod. 100583 ~ B0 cm 100x140 *

*Costi di imballaggio per cornici 100x140 cm.
*Packing cost for snap frames 100x140 cm.

cod. 100020 ~ PACKING COST *



WINDOW FRAME | CORNICE DOPPIA PER VETRINA

Doppia cornice a scatto senza fondo. Si applicano con biadesivo sulle due facciate della vetrata. Disponibili con profilo da 19 mm. angolo vivo e con profilo da 25 mm. con angolo tondo e angolo vivo. Formati disponibili: A4, A3, cm. 50x70 e cm. 70x100.

- Profili 19 e 25 mm.
- Formati disponibili A3, A4, 50x70 e 70x100 cm.
- Angolo Tondo o Angolo Vivo
- Biadesivo già applicato
- Set composto da 2 cornici
- Profile 19 or 25 mm.
- Available A3, A4, 50x70 and 70x100 cm.
- Round or Mitred Corner
- Biadhesive applied
- Set composed by 2 snap frames

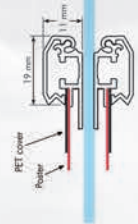
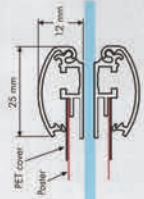
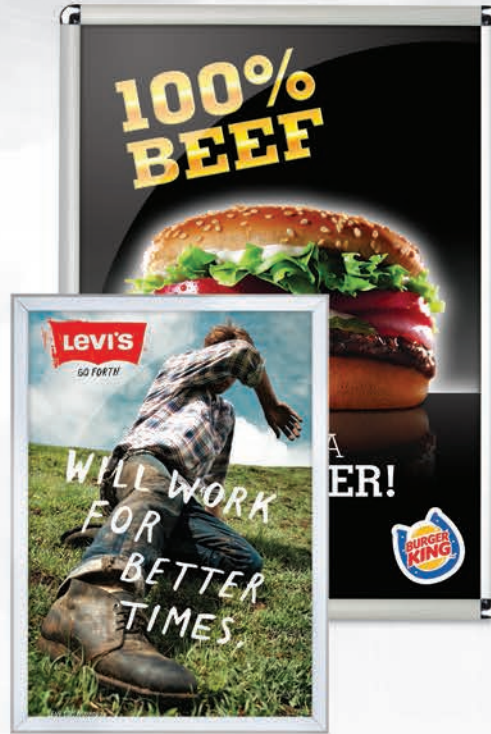

PROFILO 19 mm. ANGOLO VIVO

cod. 100152 ~ WINDOW FRAME A4 - MC19
cod. 100153 ~ WINDOW FRAME A3 - MC19
cod. 100154 ~ WINDOW FRAME 50x70 - MC19
cod. 100155 ~ WINDOW FRAME 70x100 - MC19

PROFILO 25 mm. ANGOLO TONDO

cod. 100156 ~ WINDOW FRAME A4 - RC25
cod. 100157 ~ WINDOW FRAME A3 - RC25
cod. 100158 ~ WINDOW FRAME 50x70 - RC25
cod. 100159 ~ WINDOW FRAME 70x100 - RC25

PROFILO 25 mm. ANGOLO VIVO

cod. 100160 ~ WINDOW FRAME A4 - MC25
cod. 100161 ~ WINDOW FRAME A3 - MC25
cod. 100162 ~ WINDOW FRAME 50x70 - MC25
cod. 100163 ~ WINDOW FRAME 70x100 - MC25



WATER RESISTANT FRAME | ALL'ACQUA

Cornice a scatto resistente all'acqua. Realizzata in alluminio con guarnizione in gommapiuma che circonda l'interno del telaio e fori di drenaggio per l'acqua sulla parte posteriore dei profili. Ideale per utilizzo all'esterno. Dimensioni disponibili: A4 - A3 - 70x100 cm.

- Profilo 25 mm. - Angolo Vivo
- Dimensioni disponibili: A4 - A3 - 70x100 cm.
- Ideale per utilizzo esterno
- Guarnizione in gommapiuma
- Provvista di fori per il drenaggio
- Profile 25 mm. - Mitred Corner
- Available sizes: A4 - A3 - 70x100 cm.
- Suitable use in outdoor conditions
- Foam rubber surrounding the frame.
- Water drainage holes on the frame

cod. 100164 ~ WATERPROOF FRAME A4
cod. 100165 ~ WATERPROOF FRAME A3
cod. 100167 ~ WATERPROOF FRAME 70x100

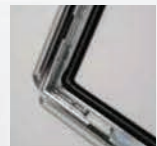

MITRED CORNER

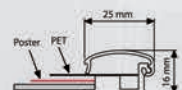



DOUBLE SIDED FRAME | CORNICE BIFACCIALE

Cornice a scatto bifacciale. Realizzata in alluminio. Utilizzo a sospensione. Possibilità di aggiungere più cornici una sotto l'altra, creando una composizione su cavo. Disponibile con profili da 25 mm. con angolo vivo. Dimensione: 70x100 cm.

- Profilo 25 mm.
- Cornice a scatto bifacciale
- Protezione PVC antiriflesso
- Angolo Vivo
- Utilizzo a sospensione su cavo
- Ganci per sospensione inclusi
- Dimensione disponibile 70x100 cm

- Profile 25 mm
- Can be viewed from both sides.
- Anti-glare cover sheet
- Mitred Corner
- Use suspended on wire
- Hanging hooks included
- Available 70x100 cm

ANGOLO VIVO

cod. 100170 ~ DOUBLE SIDED FRAME 70x100 - MC

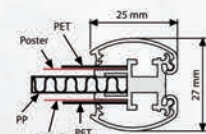
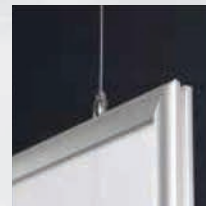
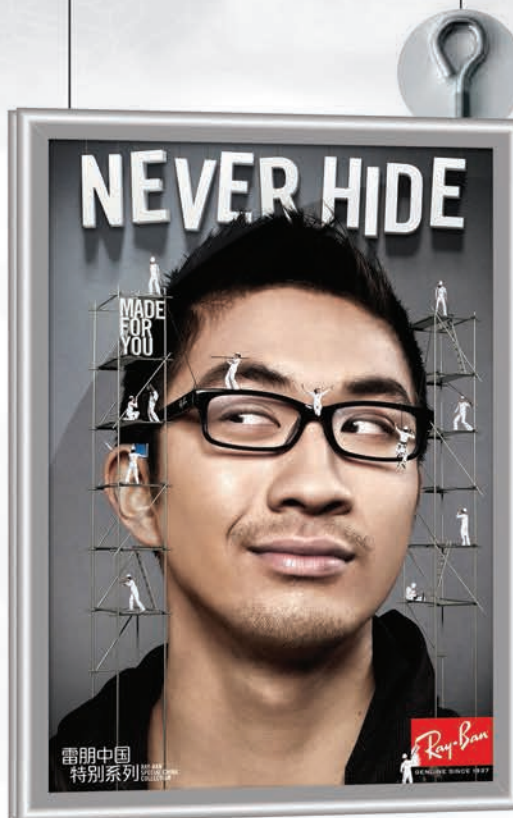

cod. 102654



SLIDE IN FRAME | CORNICE SLIDE IN

Cornice bifacciale con piedistallo. Realizzata in alluminio. Sostituzione del messaggio semplice e veloce, si inserisce lateralmente in modo "slide in". Dotata di biadesivo alla base per essere applicata anche a bandiera sulle pareti. Grazie alla gomma di tenuta può essere usata anche all'esterno. Ideale sia per scrivanie o banconi che per pareti.

- Cornice Bifacciale da banco e parete
- Angolo Vivo
- Sostituzione del messaggio "Slide In"
- Dotata di biadesivo sulla base
- Dimensioni disponibili A4 e A3
- Orizzontale o Verticale

- Double Sided Frame for counter or wall
- Mitred Corner
- Slide your message in or out
- Double-sided tape at the bottom
- Available A4 and A3
- Portrait or Landscape

VERTICALE

cod. 100171 ~ SLIDE IN FRAME A4 - PORTRAIT

cod. 100172 ~ SLIDE IN FRAME A3 - PORTRAIT

ORIZZONTALE

cod. 100173 ~ SLIDE IN FRAME A4 - LANDSCAPE

cod. 100174 ~ SLIDE IN FRAME A3 - LANDSCAPE

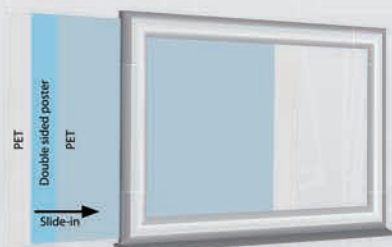



MAGIC FRAME | CORNICE CON CHIUSURA MAGNETICA

Pratica cornice. Realizzata in alluminio, fondo in polionda e cover in plastica trasparente con chiusura magnetica. Può essere montata sia verticale che orizzontale. Sostituzione del messaggio facile e veloce. Formati A3 - A4 - A5. Spessore 10 mm.

Practical frame. Made of aluminum, plastic back panel, clear cover magnetic closure. It can be mounted portrait or landscape. Easy & quick poster change. Available: A3 - A4 - A5. Thickness 10 mm.

cod. **100200** ~ MAGIC FRAME A5

cod. **100201** ~ MAGIC FRAME A4

cod. **100202** ~ MAGIC FRAME A3



ROADSIGN FRAME | CORNICE PER PALO STRADALE

Cornice a scatto con applicate 2 staffe per montaggio su palo stradale da diametro 60 mm. Disponibile nei formati A3 e A4 con angolo vivo. Profilo 25 mm.

- Profilo 25 mm.
- Angolo Vivo
- Staffe per palo incluse
- Resistente all'acqua
- Palo non incluso

- Profile 25 mm.
- Round or Mitred Corner
- Brackets for pole Included
- Waterproof
- Pole not included



ANGOLO VIVO

cod. **100177** ~ ROAD SIGN FRAME A4 - MC

cod. **100178** ~ ROAD SIGN FRAME A3 - MC



CLING | SOSTEGNO PER CORNICI A SCATTO

Sostegno per cornici "Snap Frame". Per un utilizzo alternativo della cornice. Posizionata su superfici piane, diventa un porta avviso o un espositore da banco. Formato max. supportato A4.

A practical support for the aluminum frames "Snap Frame". Maximum frame size supported A4.

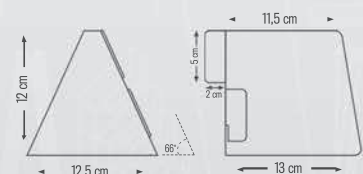
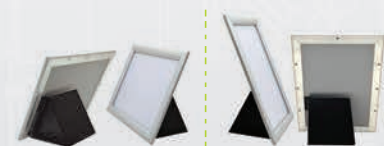

cod. **100141** ~ CLING



CORNICI A SCATTO | SPAREPARTS RICAMBI | klikclak



Protezione per frame cornici a scatto in PVC antigraffio lucido gofrato spessore 0.45/0.50 mm.

PVC cover for snap frames polished embossed thickness 0.45/0.50 mm.

cod. **100041** ~ PVC COVER A4 cm 21x29,7

cod. **100042** ~ PVC COVER A3 cm 42x29,7

cod. **100043** ~ PVC COVER B2 cm 50x70

cod. **100044** ~ PVC COVER B1 cm 70x100

cod. **100045** ~ PVC COVER B0 cm 100x140

PVC COVER



25 mm

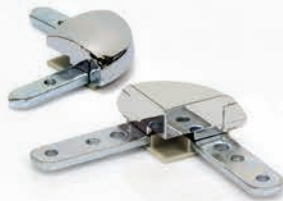

Angolo tondo cromato per cornici a scatto completo di squadra di collegamento in ferro. Viti non incluse.

Round corner for snap frames. Finished polished. Screw not included.

cod. **100026** ~ ROUND CORNER 25 mm

cod. **100027** ~ ROUND CORNER 32 mm

ROUND CORNER



32 mm

25 mm



Connettore in ferro angolo vivo per cornici a scatto - viti non incluse.

Iron mitred corner connector for snap frames. Screw not included.

cod. **100028** ~ MITRED CORNER 25 mm

cod. **100029** ~ MITRED CORNER 32 mm

cod. **100039** ~ MITRED CORNER 44 mm

MITRED CORNER



32 mm

44 mm



Set viti da 4 pz. per angoli e squadre delle cornici a scatto. Confezione da 4 pz.
Set 4 pcs screw for round corner or mitred corner.

cod. **100030** ~ GRAP for 25 mm

cod. **100031** ~ GRAP for 32 mm

GRAP



Molle in alluminio per cornici a scatto. Confezione da 4 pz.

Spring for snap frames. Set 4 pcs

cod. **100035** ~ SPRING for 25 mm

cod. **100036** ~ SPRING for 32 mm

SPRING

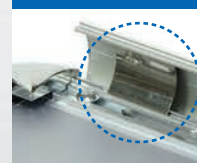

Ganci per cornici a scatto. Set 2 pz.
Hangers help easy mounting. Set 2 pcs

cod. **100032** ~ FRAME HANGER

FRAME HANGER





CORNICI A SCATTO | PROFILE PROFILI | klikclak

Profili in alluminio per creare cornici a scatto su misura. Set profilo completo, costituito da componente superiore, componente inferiore e molle di chiusura klik clak. Il componente superiore si presenta con finitura argento opaco, mentre quello inferiore con finitura lucida. Disponibile nella larghezza 25 mm, 32 mm. e 44 mm. Lunghezza 300 cm.

Aluminium snap profile set (top, bottom and spring) in 300 cm. Top profile it's silver anodized. Bottom profile is mill finished. Available 25 mm, 32 mm. and 44 mm.

WOODEN BOX



I profili sono spediti in cassonetti di legno. We ship only with wood box.

cod. 100025 ~ WOODEN BOX

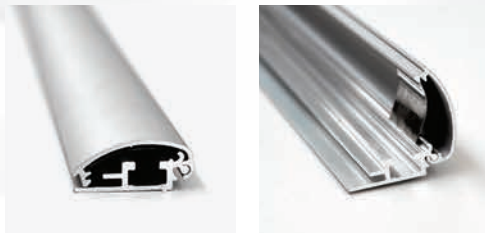

SNAP FRAME PROFILE 25 mm.

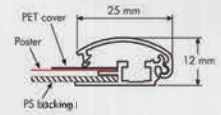

cod. 100021 ~ SET PROFILE 25 mm. - 300 cm.

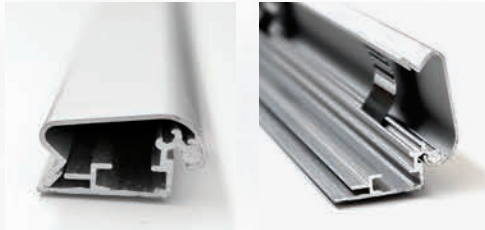

SNAP FRAME PROFILE 32 mm.

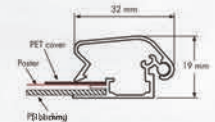

cod. 100022 ~ SET PROFILE 32 mm. - 300 cm.



SNAP FRAME PROFILE 44 mm.

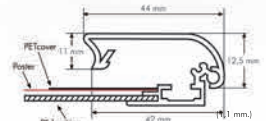

cod. 100023 ~ SET PROFILE 44 mm. - 300 cm.



CORNICI A SCATTO | CUSTOM SNAPFRAME SU MISURA | klikclak

RILASSATI, CI PENSIAMO NOI !

Per esigenze particolari, per cornici fuori standard e per qualsiasi altra esigenza Ark Display mette a tua completa disposizione l'area customs products. L'area dedicata alla realizzazione della cornice a scatto su misura per te. Potrai realizzare la tua cornice scegliendo la larghezza dei profili, la dimensione della cornice. Nessun ordine minimo.

RELAX, WE MAKE IT!

For special requirements. Send us the size of your snap frame. We Make It !

RILASSATI CI PENSIAMO NOI !



ROUND CORNER



MITRED CORNER



SNAP FRAME PROFILE 25 mm.



SNAP FRAME PROFILE 32 mm.



SNAP FRAME PROFILE 44 mm.





LIGHT LED FRAME | CORNICE LUMINOSA LED

Cornice a scatto con illuminazione led. Alta luminosità ottenuta grazie allo speciale fondo in acrilico che rende omogenea la luce. Il pulsante on-off e l'alimentatore esterno contribuiscono a dare lunga vita al prodotto. Svariati utilizzi possibili. Sostituzione veloce del messaggio grazie all'apertura click-clack.

- Profilo 25 mm. - Profondità 19 mm.
- Angolo Vivo
- Interruttore ON-OFF
- Sistema click-clack
- Luminosità brillante e omogenea
- 2 Ganci per fissaggio a parete inclusi

- Profile 25 mm. - Depth 19 mm.
- Mitred corner
- ON-OFF Button
- Click-clack system
- Homogenous and brilliant
- 2 wall hangers included

cod. 100589 ~ LIGHT LED FRAME 50x70 | 2900 ~ 3200 LUX

cod. 100590 ~ LIGHT LED FRAME 70x100 | 2500 ~ 2800 LUX

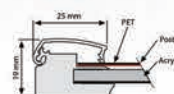
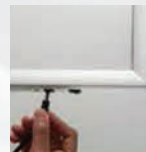
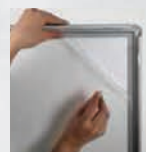

LED PANEL FRAME | CORNICE PER PLEXI&LED

Cornice realizzata con particolare profilo in alluminio. All'interno del profilo possono essere montati i led. Per il fondo si consiglia l'utilizzo di un pannello di PMMA trasparente che favorirebbe la propagazione della luce. Una soluzione di alto impatto visivo e dagli svariati utilizzi.

- Profilo 24,4 mm. - Profondità 19 mm.
- Angolo Vivo
- Fondo in PMMA - NON incluso
- LED - NON inclusi

- Profile 24,4 mm. - Depth 19 mm.
- Mitred corner
- Panel of PMMA - NOT included
- LED - NOT included



UTILIZZO CONSIGLIATO



cod. 100598 ~ LED PANEL FRAME 50x70

cod. 100599 ~ LED PANEL FRAME 70x100

MINI MODULI LED



cod. 645303
confezione 20 pz (1,45 mt)

ALIMENTATORE PER LED



cod. 645551 ~ 12V - 2A
cod. 645552 ~ 12V - 5A

CONNETTORE PER ALIMENTATORE



cod. 645550

PANNELLI PMMA



cod. 101034 ~ PMMA 50x70 - 8mm.
cod. 101035 ~ PMMA 70x100 - 8mm.



TEX FRAME | CORNICE TENSIONAMENTO TESSILE

Cornice monofacciale realizzata in alluminio con blocco a tensionamento tessile. Realizzata con particolare supporto in silicone che permette di bloccare e tensionare la stampa, realizzata su tessuto o banner, direttamente nel profilo. Sostituzione del messaggio semplice e veloce.

- Profondità profilo 17 mm.
- Angolo Vivo
- Realizzata in alluminio
- Tensionamento tessile

- Profile depth 17 mm.
- Mitred corner
- Made of aluminium
- Textile tensioning

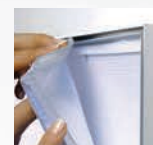
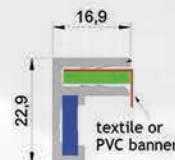

Supporto in silicone per tensionare la stampa direttamente nel profilo. **NON INCLUSO**

cod. 103407 ~ SUPP. SILICONE - 1 METRO

cod. 103101 ~ TEX FRAME A4 - 21x29,7 cm
cod. 103102 ~ TEX FRAME A3 - 42x29,7 cm
cod. 103103 ~ TEX FRAME A2 - 42x59,4 cm
cod. 103104 ~ TEX FRAME A1 - 59,4x84 cm

cod. 103105 ~ TEX FRAME A0 - 84x119 cm
cod. 103106 ~ TEX FRAME B2 - 50x70 cm
cod. 103107 ~ TEX FRAME B1 - 70x100 cm
cod. 103108 ~ TEX FRAME B0 - 100x140 cm

cod. 103109 ~ TEX FRAME 33 - 30x30 cm
cod. 103110 ~ TEX FRAME 44 - 40x40 cm
cod. 103111 ~ TEX FRAME 55 - 50x50 cm
cod. 103112 ~ TEX FRAME 51 - 50x100 cm
cod. 103113 ~ TEX FRAME 100 - 100x100 cm



MUSEUM FRAME | CORNICE ELEGANTE A GIORNO

Cornice per pannelli, monofacciale, a giorno. Realizzata in lega di alluminio di alta qualità (6063). Il profilo tondeggiante conferisce alla cornice un aspetto elegante e raffinato. Colore standard argento. Su richiesta disponibile anche nei colori nero, oro e rosso.

- Profilo a vista 7 mm.
- Profondità profilo 16,5 mm.
- Angolo Vivo
- Realizzata in alluminio (6063)
- Colori: Argento, nero, oro, rosso
- Può ospitare pannelli fino a 10 mm. di spessore

- Visible profile 7 mm.
- Profile depth 16,5 mm.
- Mitred corner
- Made of aluminium alloy 6063
- Colour: Silver, black, gold, red
- For panels up to 10 mm thick

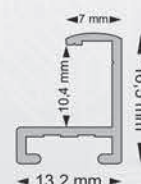
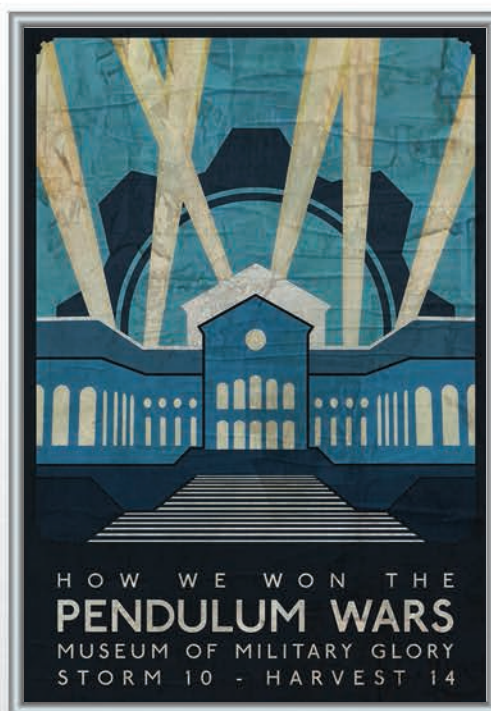

*COLORE STANDARD ARGENTO
COLORI DISPONIBILI SU RICHIESTA: NERO, ORO, ROSSO.

cod. 103114 ~ MUSEUM FRAME A4 - 21x29,7 cm
cod. 103115 ~ MUSEUM FRAME A3 - 42x29,7 cm
cod. 103116 ~ MUSEUM FRAME A2 - 42x59,4 cm
cod. 103117 ~ MUSEUM FRAME A1 - 59,4x84 cm

cod. 103118 ~ MUSEUM FRAME A0 - 84x119 cm
cod. 103119 ~ MUSEUM FRAME B2 - 50x70 cm
cod. 103120 ~ MUSEUM FRAME B1 - 70x100 cm
cod. 103121 ~ MUSEUM FRAME B0 - 100x140 cm

cod. 103122 ~ MUSEUM FRAME 33 - 30x30 cm
cod. 103123 ~ MUSEUM FRAME 44 - 40x40 cm
cod. 103124 ~ MUSEUM FRAME 55 - 50x50 cm
cod. 103125 ~ MUSEUM FRAME 51 - 50x100 cm
cod. 103126 ~ MUSEUM FRAME 100 - 100x100 cm



POSTER EASY | PRINTSUPPORT

Profili in alluminio porta stampe. Disponibili in quattro misure diverse. Grazie alle pinze in plastica reggi poster, il poster easy si presenta come un'ottima soluzione per esporre foto e poster. Può essere utilizzato sia in verticale che in orizzontale. Il prodotto viene fornito smontato. E' possibile fissare il "poster easy" anche su vetro aggiungendo l'accessorio "suker".
Poster Easy viene fornito smontato completo di angoli in plastica e n° 4 pinze. Si consiglia l'utilizzo con poster in carta. Le pinze potrebbero rovinare la stampa.

Lightweight frame that stretches the poster from 4 corners. Easy poster change. Crocodile clips grip and tension the poster. Includes 2 sliding plastic hangers for both wallmounting and ceiling suspending. Available as standard in silver anodised aluminium. Use landscape or portrait. Each pack includes 4 clips & n° 2 hanger. Suggested poster material is paper, any heavier material such as vinyl or textile may damage the springs on the corner.



KIT EASY CELING



Kit montaggio a sospensione.
2pz. Altezza Max. 2mt.
Kit to put in suspension.
2pcs. Max High: 2 mt.

cod. 102654 ~KIT EASY CELING

SUCKER



Coppia di ventose per montaggio su vetro. MAX 2 Kg.
Suction cup for windows. 2 pcs.
2. MAX 2 Kg.

cod. 102657 ~SUCKER (2 pcs)

Poster Easy	Size	Poster	External	Copy
cod. 102631	A4	cm 21x29,7	cm 31x39,7	cm 21x29,7
cod. 102632	A3	cm 42x29,7	cm 52x39,7	cm 42x29,7
cod. 102633	B2	cm 50x70	cm 60x80	cm 50x70
cod. 102634	B1	cm 70x100	cm 80x110	cm 70x100



SNAPPY | PRINTSUPPORT

Snappy, set di n° 2 profili in alluminio da 25 mm. Ideale per esporre immagini di qualsiasi altezza. Il semplice meccanismo a scatto consente di cambiare il messaggio in pochissimi istanti. La gomma antiscivolo all'interno garantisce la tenuta anche per stampe su carta e tessuto a basso spessore. Viene fornito con ganci per il fissaggio a parete/soffitto. Disponibile in varie dimensioni e nella lunghezza 300 cm. per composizioni personalizzate.

- Profilo a Scatto
- Kit fornito già montato.
- Completo di anelli (Hanger) e tappi laterali.
- Si consiglia l'utilizzo di stampe poco spesse.

Set of n° 2 aluminium snap profiles 25 mm. silver anodised finish with black plastic end caps and sliding hooks. Inside the snap profiles have integrated black foam rubber strips. One set includes n° 2 profiles: the upper and the bottom profiles.

- Snap Profile
- All set included hanger and end caps.
- No tool assembly.

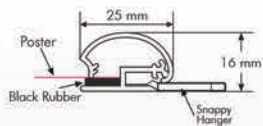

Set Snappy	Size	Poster	External
cod. 102661	SNAPPY 21	cm 21	cm 21,6
cod. 102662	SNAPPY 30	cm 30	cm 30,6
cod. 102663	SNAPPY 42	cm 42	cm 42,6
cod. 102641	SNAPPY 50	cm 50	cm 50,6
cod. 102642	SNAPPY 60	cm 60	cm 60,6
cod. 102643	SNAPPY 70	cm 70	cm 70,6
cod. 102644	SNAPPY 80	cm 80	cm 80,6
cod. 102664	SNAPPY 85	cm 85	cm 85,6
cod. 102645	SNAPPY 100	cm 100	cm 100,6
cod. 102665	SNAPPY 120	cm 120	cm 120,6
cod. 102666	SNAPPY 150	cm 150	cm 150,6

* SU RICHIESTA DISPONIBILI MISURE SUPERIORI

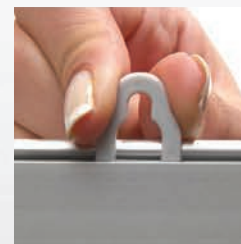

SUCKER



Coppia di ventose per montare lo Snappy su vetro. **MAX 2 Kg.**
Suction cup for windows. 2 pcs. 2. **MAX 2 Kg.**

cod. 102657 ~ SUKUR (2 pcs)

KIT EASY CELING



Kit montaggio a sospensione. 2pz. **Altezza Max. 2mt.**
Kit to put in suspension. 2pcs. **Max High: 2 mt.**

cod. 102654 ~ KIT EASY CELING



CLAMP | PRINTSUPPORT

Coppia di profili porta poster. Realizzati completamente in alluminio anodizzato. Il poster è trattenuto dalla pressione dei profili. Maggiore è lo spessore del poster e maggiore è la resistenza alla chiusura. I ganci scorrevoli permettono una facile installazione. Ideale per stampe banner e striscioni. Disponibili in varie dimensioni e in profili da 300 cm.

- Profilo a Pressione (incastro)
- Per stampe con spessore da 50 a 500 micron
- Fornito montato in buste singole (a coppia)
- Complete di anelli (hanger) e tappi laterali.

Profiles poster. Made in anodized aluminum. Ideal for printing banners. Thickness from 50 to 500 microns. Available in different sizes.

- Clamp Profile
- All set included hanger and end caps.
- No tool assembly.

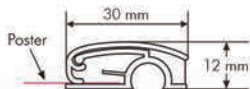

Set Clamp	Size	Poster	External
cod. 102667	CLAMP 21	cm 21	cm 21,6
cod. 102668	CLAMP 30	cm 30	cm 30,6
cod. 102669	CLAMP 42	cm 42	cm 42,6
cod. 102670	CLAMP 50	cm 50	cm 50,6
cod. 102671	CLAMP 60	cm 60	cm 60,6
cod. 102647	CLAMP 70	cm 70	cm 70,6
cod. 102672	CLAMP 80	cm 80	cm 80,6
cod. 102673	CLAMP 85	cm 85	cm 85,6
cod. 102648	CLAMP 100	cm 100	cm 100,6
cod. 102674	CLAMP 120	cm 120	cm 120,6
cod. 102660	CLAMP 150	cm 150	cm 150,6

* SU RICHIESTA DISPONIBILI MISURE SUPERIORI

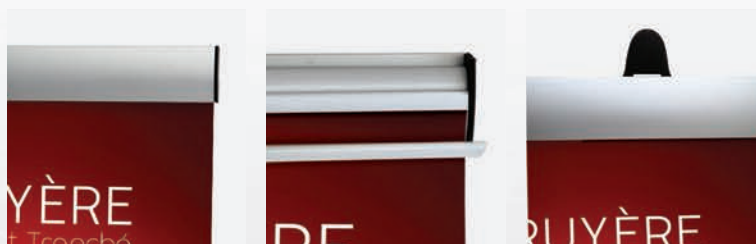

SUCKER



Coppia di ventose per montare lo Snappy su vetro. **MAX 2 Kg.**
Suction cup for windows. 2 pcs. 2. **MAX 2 Kg.**

cod. 102657 ~ SUKUR (2 pcs)

KIT EASY CELING



Kit montaggio a sospensione. 2pz. **Altezza Max. 2mt.**
Kit to put in suspension. 2pcs. **Max High: 2 mt.**

cod. 102654 ~ KIT EASY CELING



COMPONENTI | SNAPPY

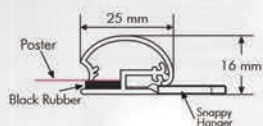

SNAPPY PROFILE

Profilo Snappy - cm 300x2,5. Completo di gomma antiscivolo e molle di chiusura. Hanger ed "End Caps" NON inclusi.



Snappy profiles 300 cm. - 25 mm. Aluminium silver anodized with spring and rubber. Hanger and "End Caps" NOT included.

cod. 102651 ~ SNAPPY PROFILE 300 cm *

SNAPPY HANGER



Coppia di anelli in plastica per sospensione profili Snappy.

Snappy Hanger - Plastic - 2 pcs.

cod. 102653 ~ SNAPPY HANGER (2pcs.)

SNAPPY END CAPS



Coppia di tappi per profili Snappy Plastica Nera

Snappy End Caps - Black Plastic 2 pcs.

cod. 102652 ~ SNAPPY END CAP (2pcs.)

CUT SERVICE



Servizio taglio su misura. Nessun ordine minimo richiesto. Cutting service. No minimum order required.

cod. 2401 ~ STARTING COST

cod. 2402 ~ CUT COST (EACH)

SUCKER



Coppia di ventose per montare il Clamp su vetro. MAX 2 Kg.

Suction cup for windows. 2 pcs. 2. MAX 2 Kg.

cod. 102657 ~ SUKER (2 pcs)

KIT EASY CELING



Kit montaggio a sospensione. 2pz. Altezza Max. 2mt.

Kit to put in suspension. 2pcs. Max High: 2 mt.

cod. 102654 ~ KIT EASY CELING

* I Profili 300 cm vengono spediti in cassonetti in Legno.

* We ship only with wood box

cod. 100025 ~ WOODEN BOX *



COMPONENTI | CLAMP



SNAPPY PROFILE

Profilo Clamp - cm 300x3. Hanger ed "End Caps" NON inclusi.



Clamp profiles 300 cm. - 30 mm. Aluminium silver anodized. Hanger and "End Caps" NOT included.

cod. 102649 ~ CLAMP PROFILE 300 cm *

CLAMP HANGER



Coppia di anelli in plastica per sospensione profili Clamp.

Clamp Hanger - Plastic - 2 pcs.

cod. 102656 ~ CLAMP HANGER (2pcs.)

CLAMP END CAPS



Coppia di tappi per profili Clamp Plastica Nera

Clamp End Caps - Black Plastic 2 pcs.

cod. 102655 ~ CLAMP END CAP (2pcs.)

CUT SERVICE



Servizio taglio su misura. Nessun ordine minimo richiesto. Cutting service. No minimum order required.

cod. 2401 ~ STARTING COST

cod. 2402 ~ CUT COST (EACH)

SUCKER



Coppia di ventose per montare il Clamp su vetro. MAX 2 Kg.

Suction cup for windows. 2 pcs. 2. MAX 2 Kg.

cod. 102657 ~ SUKER (2 pcs)

KIT EASY CELING



Kit montaggio a sospensione. 2pz. Altezza Max. 2mt.

Kit to put in suspension. 2pcs. Max High: 2 mt.

cod. 102654 ~ KIT EASY CELING

* I Profili 300 cm vengono spediti in cassonetti in Legno.

* We ship only with wood box

cod. 100025 ~ WOODEN BOX *



POSTER | PROFILI FAST | PORTA POSTER

Coppia di profili portaposter realizzati in alluminio. All'interno sono presenti dei binari in plastica dove inserire velocemente la stampa. Ideali per negozi, supermercati, vetrine, ecc. Utilizzabile sia monofacciale che bifacciale. Sono inclusi i ganci scorrevoli per il fissaggio dei profili sia a parete che a sospensione.

- Set composto da 2 profili in alluminio
 - Binari portafoglio inclusi nei profili
 - Ganci scorrevoli inclusi
 - Fissaggio a parete ed a sospensione
 - Rapida sostituzione del messaggio
- Set consist of 2 aluminium profile
 - Special clamp inside the profile
 - Sliding hook included
 - Suitable for wall mounting or ceiling hanging
 - Fast substitution of messages

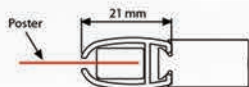

cod. **100180** ~ POSTER FAST - 70 cm.

cod. **100182** ~ POSTER FAST - 100 cm.

cod. **100181** ~ POSTER FAST - 85 cm.

cod. **100183** ~ POSTER FAST - 120 cm.

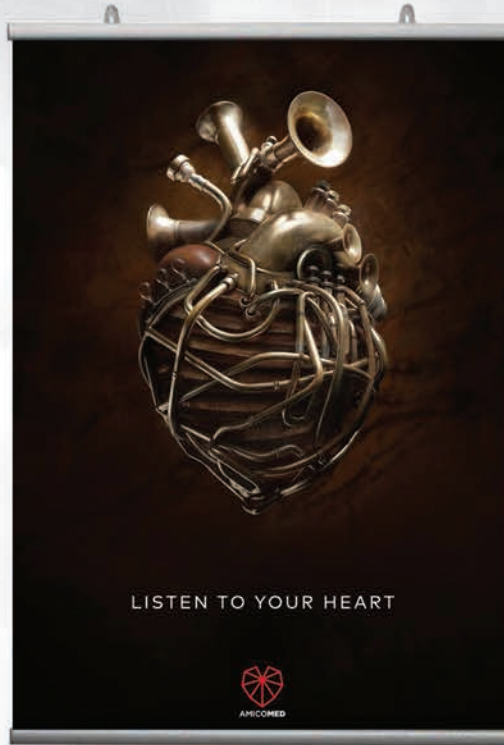

cod. **102654** ~ KIT EASY CELING



FAST | BINARIO RAIL | PORTA AVVISI

Binario porta avvisi che consente di sostituire i messaggi in modo facile ed immediato. Non bisogna aprire o smontare nulla, basta inserire i messaggi dal basso che vengono trattenuti da una serie di rulli in plastica contenuti nel binario. La soluzione ideale per sale riunioni, uffici, segreterie, cucine di ristoranti, ecc. Completati di tappi, profili copriforo e biadesivo sul retro.

- Sostituzione immediata del messaggio
- Tappi inclusi
- Profili copriforo inclusi
- Biadesivo sul retro incluso

- Fast substitution of messages
- for use within meeting rooms, offices, secretariat and restaurants
- End cap included
- Hole cover profile included
- Double-sided tape at the back side

cod. **100184** ~ FAST RAIL - 31 cm.

cod. **100186** ~ FAST RAIL - 88 cm.

cod. **100185** ~ FAST RAIL - 50 cm.

cod. **100187** ~ FAST RAIL - 100 cm.

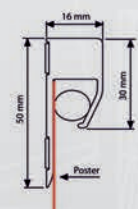
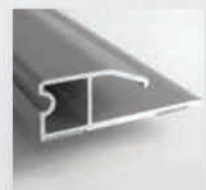



PROFILO **32 mm**

A-BOARD CLASSIC | CAVALLETTO clikclak

Cavalletto bifacciale con cornici a scatto. Il prodotto di comunicazione visiva più utilizzato negli aeroporti, stazioni, negozi, centri commerciali e nei luoghi pubblici in genere. Le cornici a scatto applicate sui cavalletti utilizzano il sistema di chiusura di tipo clik-clak con protezione in pvc antiriflesso.

- Formati cm 50x70 - 70x100 - 100x140
- Profilo cornici 32 mm.
- Fondo in lamiera metallica
- Angolo tondo cromato
- Sistema clik-clak
- Protezione pvc antiriflesso
- Imballato singolarmente
- Fornito già montato

A-board double sided with applied snap frames, pvc cover anti-reflective, plate back side. A-board the most used in airports, stations, shops, malls and public places. The snap frames applied use clik-clak system.

- Available: cm 50x70 - 70x100 - 100x140
- 32 mm profile
- Iron back panel
- Chrome round corner
- Clik-clak system
- Pvc cover
- Single packed
- No tool assembly



A-Board Classic	Size	Poster	External HxLxD	Weight	CTN	PLT
cod. 100051	50x70	B2 cm 50x70	cm 94x54x67	Kg 8,5 ca.	1	20
cod. 100052	70x100	B1 cm 70x100	cm 116x74x85	Kg 12 ca.	1	10
cod. 100053 *	100x140	B0 cm 100x140	cm 160x104x114	Kg 20 ca.	1	5

*Costi di imballaggio per cornici 100x140 cm.
*Packing cost for snap frames 100x140 cm.

cod. **100020** ~ PACKING COST *

BASKET A4

Cestino portadepliant A4 in metallo cromato.
Iron basket chrome din A4

cod. **100069** ~ BASKET A4





PROFILO **25 mm**

A-BOARD BASIC | CAVALLETTO BASIC

clikclak

Cavalletto bifacciale con cornici a scatto. Può essere accessorizzato anche con il cestino laterale.

- Formati cm 50x70 - 70x100
- Profilo cornici 25 mm.
- Fondo in plastica
- Angolo tondo cromato
- Sistema clik-clak
- Protezione pvc antiriflesso
- Imballato singolarmente
- Fornito già montato
- Available: cm 50x70 - 70x100
- 25 mm profile
- Plastic back panel
- Chrome round corner
- Clik-clak system
- Pvc cover
- Single packed
- No tool assembly



A-Board Basic	Size	Poster	External HxLxD	Weight	CTN	PLT
cod. 100058	50x70	B2 cm 50x70	cm 94x53x67	Kg 7,3 ca.	1	20
cod. 100060	70x100	B1 cm 70x100	cm 116x73x85	Kg 11 ca.	1	10

BASKET A4

Cestino portadepliant A4 in metallo cromato. Iron basket chrome din A4



cod. 100069 ~ BASKET A4



PROFILO **25 mm**

A-BOARD SINGLESIDE | CAVALLETTO SINGLESIDE

clikclak - mono

- Monofacciale
- F.to 70x100
- Profilo cornici 25 mm.
- Fondo in plastica
- Angolo tondo cromato
- Sistema clik-clak
- Protezione pvc
- Imballato singolarmente
- Fornito già montato
- Single Side
- 25 mm profile
- 70x100 cm
- Plastic back panel
- Chrome round corner
- Clik-clak system
- Pvc cover
- Single packed
- No tool assembly



A-Board Single Side	Size	Poster	External HxLxD	Weight	CTN	PLT
cod. 100059	70x100	B1 cm 70x100	cm 116x73x85	Kg 3,9 ca.	1	18

BASKET A4

Cestino portadepliant A4 in metallo cromato. Iron basket chrome din A4



cod. 100069 ~ BASKET A4



PROFILO 32 mm.

BLACK/WHITE A-BOARD

CAVALLETTO clikclak

Cavalletto bifacciale scrivibile. Disponibile con fondo lavagna (BLACK) o con fondo magnetico bianco (WHITE). Protezione in pvc.

- Formato cm 70x100
- Fondo scrivibile - magnetico/scrivibile
- Profilo cornici 32 mm.
- Fondo in lamiera metallica
- Angolo tondo cromato
- Sistema clik-clak
- Protezione pvc
- Imballato singolarmente
- Fornito già montato

Writable a-board double sided. Available with chalkboard surface (BLACK) or white magnetic surface (WHITE). Snap frames 32 mm profile, round corner, pvc cover anti-reflective. The snap frames applied use clik-clak system and the pvc cover allows use even outside. Available Sizes 70x100 cm.

- Writable/Magnetic A-Board
- 32 mm profile
- Iron back panel
- Chrome round corner
- Clik-clak system
- Pvc cover
- Single packed
- No tool assembly



Black/White A-Board	Size	Poster	External HxLxD	Weight	CTN	PLT
cod. 100054 ~ BLACK A-BOARD	70x100	B1 cm 70x100	cm 116x74x85	Kg 12 ca.	1	10
cod. 100055 ~ WHITE A-BOARD	70x100	B1 cm 70x100	cm 116x74x85	Kg 12 ca.	1	10

BASKET A4

Cestino portadepliant A4 in metallo cromato. Iron basket chrome din A4

cod. 100069 ~ BASKET A4



FLUOMARKER

Pennarelli Fluorescent
Fluorescent markers

- cod. 920012 ~ GREEN
- cod. 920013 ~ YELLOW
- cod. 920014 ~ BLUETTE
- cod. 920015 ~ RED
- cod. 920016 ~ PINK
- cod. 920017 ~ WHITE
- cod. 920018 ~ ORANGE



MARKER

Pennarelli ad acqua
Dry wipe markers

- cod. 920020 ~ BLACK
- cod. 920021 ~ BLUE
- cod. 920022 ~ RED
- cod. 920023 ~ GREEN



COLOUREDCHALK



cod. 920019 ~ 10 PCS

MAGNET

Magneti 3cm. Col. Ass.
Magnet 3 cm. Mix Col.



cod. 920011 ~ 5 PCS



KING CAVALLETTO A-BOARD | Plastica

Cavalletto bifacciale realizzato in plastica termoformata. Leggero e funzionale. Adatto ad ogni esigenza. Pronto per l'utilizzo.

- Formato cm 90x50
- Imballato singolarmente
- Fornito già montato
- Personalizzabile con adesivo
- Peso 3,9 Kg
- Mado of Plastic
- Size cm 90x50
- Single packed
- No tool assembly
- Customizable with adhesive
- Weight 3,9 Kg

cod. 100151 ~ KING - CAVALLETTO PLASTICA

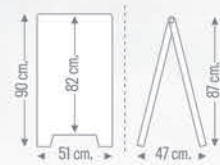

WIND CAVALLETTO DA ESTERNO

Cavalletto per esterno. Particolarmente indicato per location con condizioni climatiche difficili. Ampia base in plastica riempibile con acqua o sabbia. Cornici bifacciali a scatto applicate alla base mediante due molle in ferro che ne permettono l'oscillazione in caso di forte vento. Base provvista di ruote su un lato per facilitarne lo spostamento. Fornito smontato (base+cornici).

- Formati cm 70x100 - 100x140
- 100% resistente all'acqua
- Angolo tondo cromato
- Profilo cornici 32 mm.
- Sistema clik-clak
- Protezione pvc
- Fornito smontato (2 Cartoni)

- External pavement sign with a water or sand filled base
- High quality steel springs guarantee stability ever
- 2 wheels attached to the base
- Available cm.: 70x100 - 100x140
- 100% waterproof
- Chrome round corner
- 32 mm profile
- Klik-clak system
- Pvc cover
- Unassembled - n° 2 carton box



Wind	Size	Poster	External HxLxD	Weight	CTN	2xPLT
cod. 100061	B1 cm 70x100	cm 70x100	cm 76x136x40 ca.	Kg 14,5 ca.	1+1	18+18
cod. 100062 *	B0 cm 100x140	cm 100x140	cm 106x178x40 ca.	Kg 20,8 ca.	1+1	9+9

*Costi di imballaggio per cornici 100x140 cm.
*Packing cost for snap frames 100x140 cm.

cod. 100020 ~ PACKING COST *



BASIC SWING | CAVALLETTO DA ESTERNO

Cavalletto per esterno. Indicato per location con condizioni climatiche difficili. Cornici bifacciali con profilo da 40 mm, applicate alla base con due molle in acciaio che ne permettono l'oscillazione in caso di forte vento. Fornito smontato (base+cornici).

- Formato cm 70x100
- Profilo cornici 40 mm.
- Angolo vivo
- Sistema klik-clak
- Protezione pvc
- Fornito smontato
- Suitable for windy outdoor conditions
- Heavy and long feet on the base provides stability
- Steel springs provide flexibility to keep it stable
- Available cm.: 70x100
- 40 mm profile
- Mitred corner
- Klik-clak system
- Pvc cover
- Unassembled

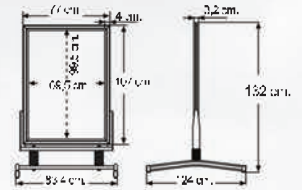

cod. 100188 ~ BASIC SWING B1 - 70X100



SWINGER 3000 | CAVALLETTO DA ESTERNO

Cavalletto per esterno. Ampia base riempibile con acqua o sabbia. Dotato di ruote per facilitare gli spostamenti.

- Formato cm 50x70
- Tasca portafoglio con chiusura magnetica
- Montaggio semplice e veloce
- Facile sostituzione del messaggio
- Area del poster 50x70 cm.
- Dotato di ruote per gli spostamenti
- Peso (con base piena) 17 kg. ca.

In-built wheels & magnetic edged poster wallet provide weather resistance in outdoor positioning.

- No tools assembly
- Easy & quick poster change
- Poster display area 50x70 cm.
- It is easy to move with rollers
- 17 kg when base is full with water

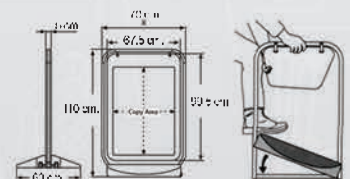

cod. 100189 ~ SWINGER 3000 - B2 - 50X70

Produced under license of
Des. Reg. No.2071096
European Patent No. EP0809227



IRON A-BOARD | CAVALLETTO IN FERRO

Cavalletto bifacciale realizzato con tubolari. Il poster viene ospitato sul cavalletto dalla sacca in PVC che si fissa al fondo in lamiera grazie alla cornice magnetica. Sulla parte superiore è presente un header personalizzabile.

- Formato 70x100 cm.
- Colore disponibile: Argento
- Tubolari ø 21 mm.
- Protezione pvc fissaggio magnetico
- Fornito già montato
- Imballato singolarmente
- Poster display stand
- Folding stand with header for branding
- For indoor and outdoor use
- Available cm.: 70x100
- Colour available: Silver
- Weather resistant
- 21 mm. diameter tubing
- PVC magnetic cover sheets
- No assembly required
- Individually packed

cod. 100191 ~ IRON A-BOARD 70x100

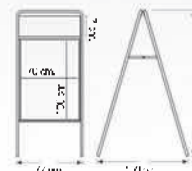
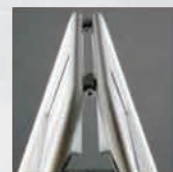

EASY GO A-BOARD | CAVALLETTO ULTRAPORTATILE

Cavalletto bifacciale ultraportatile. Design unico si richiude completamente su se stesso riducendo completamente il suo ingombro. Sui profili sono presenti i binari dove inserire i pannelli pubblicitari.

- Materiale alluminio
- Completamente richiudibile
- Formato 70x100 cm.
- Spessore max. pannelli 6 mm.
- Pannelli NON inclusi
- Fornito già montato

Easy go A Board is an ultraportable and easy to use model in A board range. With its unique foldable design, it is easy to carry and set up.

- Made of aluminium
- Unique foldable design
- Available: 70x100 cm.
- Suitable for max. 6 mm. panels
- Panels NOT included
- No assembly required

cod. 100192 ~ EASY GO A-BOARD 70x100

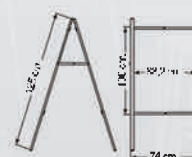
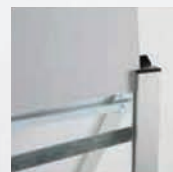



WOOD A-BOARD | CAVALLETTO LAVAGNA

Cavalletto bifacciale a lavagna scrivibile. Realizzato in legno.

- Formato lavagna mm 53x66
- Realizzato in legno
- Fondo scrivibile
- Imballato singolarmente
- Fornito già montato
- Profili legno mm 35x18

Double sided black A-board writable. Made of wood.

- Blackboard mm 53x66
- Made in wood
- Write A-Board
- Single packed
- No tool assembly
- Wood profiles mm 35x18



Wood A-Board	Chalkboard	External HxLxD	Weight	CTN	PLT
cod. 103601	cm 53x66	cm 100x60x56	Kg 3,35 ca.	1	35

FLUOMARKER

Pennarelli Fluorescent
Fluorescent markers

- cod. 920012 ~ GREEN
- cod. 920013 ~ YELLOW
- cod. 920014 ~ BLUETTE
- cod. 920015 ~ RED
- cod. 920016 ~ PINK
- cod. 920017 ~ WHITE
- cod. 920018 ~ ORANGE



COLOUREDCHALK



cod. 920019 ~ 10 PCS



SWAP | BASE PER PANNELLI

Base portapannelli bifacciale, realizzata in alluminio. Semplice utilizzo. Spessore regolabile con la vite posta sul fondo della base. Per utilizzo interno: centri commerciali, alberghi, ristoranti scuole, ecc. Si consiglia l'utilizzo con pannelli leggeri come foam o pvc espanso.

- Spessore regolabile da 5 a 10 mm.
- Disponibile nei formati 30,60, 100 cm.
- Consigliato l'utilizzo di pannelli leggeri
- Pannelli NON inclusi

- Aluminium base for light panel
- Economical and easy to use
- Adjustable thickness, from 5 to 10 mm.
- Widths available: 30, 60, 100 cm.
- Panels NOT included

cod. 100193 ~ SWAP BASE 30 cm.

cod. 100194 ~ SWAP BASE 60 cm.

cod. 100195 ~ SWAP BASE 100 cm.

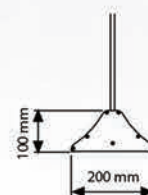
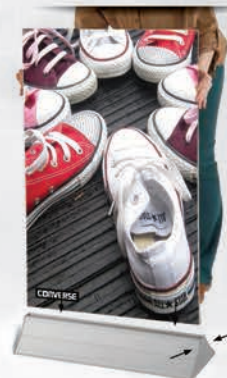
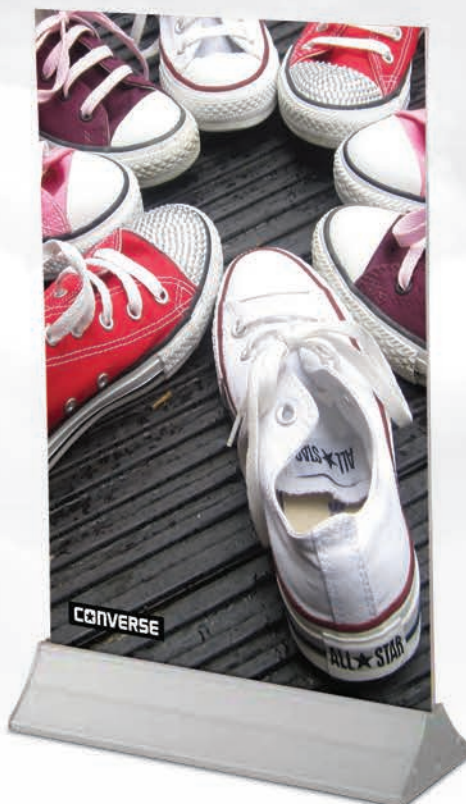

PANEL | BASE PER PANNELLI

Base portapannelli bifacciale, realizzata in acciaio verniciato a polvere. Composta da 2 pezzi che si avvitano insieme. Per utilizzo interno: centri commerciali, alberghi, ristoranti scuole, ecc. Utilizzo consigliato con pannelli leggeri come foam o pvc espanso.

- Spessore regolabile fino a 2 cm.
- Disponibile nei formati 30,60, 80, 100 cm.
- Consigliato l'utilizzo di pannelli leggeri
- Altezza massima consigliata 150 cm.
- Pannelli NON inclusi

- Coated steel base for light panel
- Economical and easy to use
- Adjustable thickness, from 5 to 10 mm.
- Widths available: 30, 60, 80, 100 cm.
- Maximum height of poster 150 cm.
- Panels NOT included

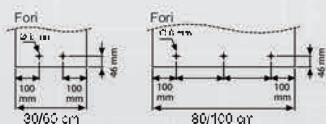

cod. 100196 ~ PANEL BASE 30 cm.

cod. 100197 ~ PANEL BASE 60 cm.

cod. 100198 ~ PANEL BASE 80 cm.

cod. 100199 ~ PANEL BASE 100 cm.





TOO THEM | TOTEM

Totem portastampe bifacciale. Realizzato in alluminio. Composto da struttura interna e profili esterni. Possono essere applicati pannelli fino a 6 mm di spessore. Le stampe possono essere realizzate anche su tessuto o banner ed essere applicate sulla struttura centrale con biadesivo o strip magnetico (NON inclusi). Su richiesta è possibile accessorizzare il totem con strip LED all'interno della struttura.

- Larghezza: 60, 80 e 100 cm. (H. 200 cm)
- Spessore struttura interna: cm. 2,7x2.
- Profilo esterno in alluminio: Larg. 4,5 cm.
- Può ospitare pannelli max. spessore 6 mm.
- Illuminazione LED su richiesta
- Base in ferro verniciato: cm. 60/80/100x35x0,5 ca.
- Biadesivo e Strip magnetico NON inclusi
- Stampa e supporto per la stampa NON inclusi

- 3 Widths available: 60-80-100 cm. (H. 200 cm)
- Thickness internal structure: cm. 2,7x2
- Aluminum external profile: Width 4.5 cm.
- Max. hard panel thickness 6 mm.
- LED lighting on request
- Iron base: cm. 60/80/100x35x0,5
- Adhesive and magnetic strip NOT included
- Print and support for printing NOT included

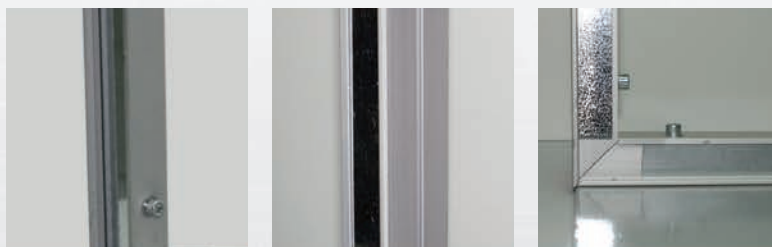

cod. 101603 ~ TOO THEM ~ 60x200

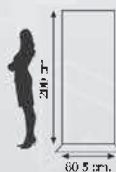

cod. 101606 ~ TOO THEM ~ 80x200



cod. 101609 ~ TOO THEM ~ 100x200

MAGNETIC STRIP

nastro magnetico con biadesivo



cod. 103510 ~ MAGNETIC STRIP ~ 398 - 12,7 mm x 30 mt

cod. 103521 ~ MAGNETIC STRIP ~ 400 - 15 mm x 30 mt



PARTITION | PARETI DIVISORIE

Sistema modulare autoportante per realizzare pareti divisorie. Il sistema è composto da pali di sostegno (a 2 vie) in alluminio con basi circolari in metallo verniciato a polvere, pannelli in alubond da 3 mm, disponibili in varie dimensioni e morsetti portapannello in alluminio. Tante soluzioni possibili.

- Pali: H.200 cm. - Basi: Ø.30 cm.
- Pannelli Alu bond spessore 3 mm.
- Pannelli personalizzabili con adesivo
- Fornito Smontato

Partition wall. Aluminium structure with iron bases. Applied Alu-Bond Panels 3 mm. thickness. Many solutions available.

- Pole: H.200 cm. - Base: Ø.30 cm.
- Alu Bond panels 3 mm. thickness
- Panels customizable with adhesive
- Unassembled

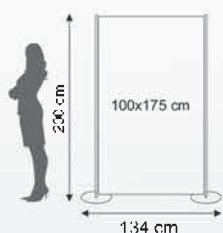

cod. 103128 ~ PARTITION - 1 MODULO

- 2x 102702 ~ EASY STAND BASE
- 2x 102703 ~ EASY STAND PROFILE
- 2x 102704 ~ EASY END CAP
- 8x 102500 ~ EASY NIPPER
- 1x ALU BOND PANEL 100X175H.



cod. 103129 ~ PARTITION - 2 MODULI

- 3x 102702 ~ EASY STAND BASE
- 3x 102703 ~ EASY STAND PROFILE
- 3x 102704 ~ EASY END CAP
- 16x 102500 ~ EASY NIPPER
- 2x ALU BOND PANEL 100X175H.



cod. 103130 ~ PARTITION - 3 MODULI

- 4x 102702 ~ EASY STAND BASE
- 4x 102703 ~ EASY STAND PROFILE
- 4x 102704 ~ EASY END CAP
- 24x 102500 ~ EASY NIPPER
- 3x ALU BOND PANEL 100X175H.



ESEMPIO DI COMPOSIZIONE

COMPONENTI

REALIZZA IL TUO PARTITION
IN BASE ALLE TUE ESIGENZE

Pannelli Alu Bond su richiesta

- 1 cod. 102703 ~ EASY STAND PROFILE - 200 cm.
- 2 cod. 102702 ~ EASY STAND BASE - Ø 30 cm.
- 3 cod. 102704 ~ EASY END CAP
- 4 cod. 102500 ~ EASY NIPPER - MORSETTO - 6,5 mm.





POINTER | SEGNALETICA DIREZIONALE

Sistema modulare per realizzare **segnaletica direzionale**. Il sistema è composto da pali di sostegno (a 2 vie) in alluminio, pannelli in alubond da 3 mm. disponibili in 2 dimensioni e morsetti portapannello in alluminio. Disponibile con pali da interrare (altezza utile 170 cm. ca.) o la variante con le basi in ferro verniciato a polvere (altezza utile 110 cm. ca.).

- Palo da interrare H.200 cm. (utile 170 cm ca.)
- Palo con base H.120 cm. - Base: Ø 30 cm.
- Pannelli Alu bond spessore 3 mm.
- Pannelli personalizzabili con adesivo
- Fornito Smontato

Directional Signal. Aluminium structure. Applied Alu-Bond Panels 3 mm. thickness. Many solutions available.

- Pole for burying H.200 cm. (Useful 170 cm. Ab.)
- Pole with base H.120 cm. - Base: Ø 30 cm.
- Alu Bond panels 3 mm. thickness
- Panels customizable with adhesive
- Unassembled

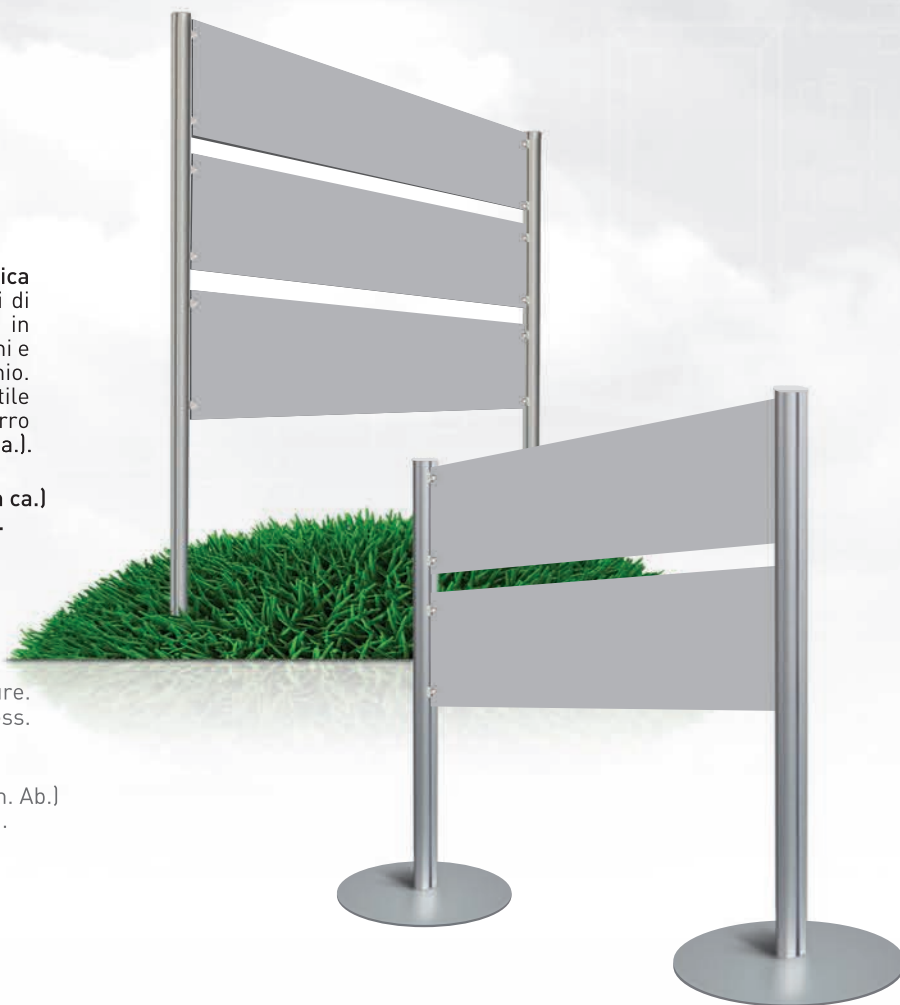

COMPONENTI



- 1 cod. 102703 ~ EASY STAND PROFILE - 200 cm.
- 2 cod. 104400 ~ EXHIBIT STANDPROFILE + BASE
- 3 cod. 102704 ~ EASY END CAP
- 4 cod. 102500 ~ EASY NIPPER - MORSETTO - 6,5 mm.

**REALIZZA IL TUO PARTITION
IN BASE ALLE TUE ESIGENZE**

Pannelli Alu Bond su richiesta

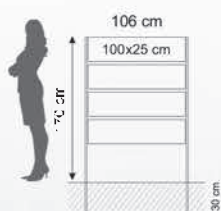

4x 100*25 cm.
cod. 103160 ~ POINTER INT. - 1 MOD.

- 2x 102703 ~ EASY STAND PROFILE
- 2x 102704 ~ EASY END CAP
- 16x 102500 ~ EASY NIPPER
- 4x ALU BOND PANEL 100x25 cm.

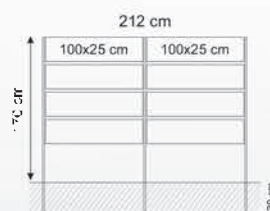

(2 modul) 4x 100*25 cm.
cod. 103161 ~ POINTER INT. - 2 MOD.

- 3x 102703 ~ EASY STAND PROFILE
- 3x 102704 ~ EASY END CAP
- 32x 102500 ~ EASY NIPPER
- 8x ALU BOND PANEL 100x25 cm.

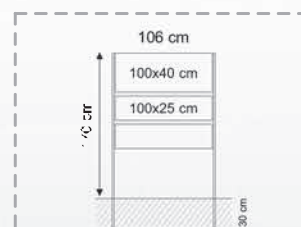

ESEMPIO DI COMPOSIZIONE

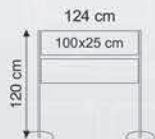

2x 100*25 cm.
cod. 103162 ~ POINTER BASE - 1 MOD.

- 2x 104400 ~ EXHIBIT STAND PROFILE + BASE
- 2x 102704 ~ EASY END CAP
- 8x 102500 ~ EASY NIPPER
- 2x ALU BOND PANEL 100x25 cm.



(2 modul) 3x 100*25 cm.
cod. 103163 ~ POINTERBASE - 2 MOD.

- 3x 104400 ~ EXHIBIT STAND PROFILE + BASE
- 3x 102704 ~ EASY END CAP
- 24x 102500 ~ EASY NIPPER
- 6x ALU BOND PANEL 100x25 cm.

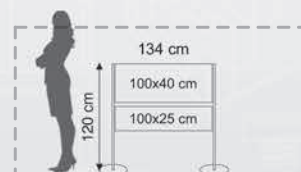

ESEMPIO DI COMPOSIZIONE



EASY POLE | CORNICI AUTOPORTANTI



Struttura espositiva Easy pole composta da palo e cornice a scatto. Facilmente componibile Easy Pole può essere configurato in tanti modi diversi. Easy Pole è composto da un montante in alluminio a 2 vie fissato su una base tonda in ferro verniciato a polvere. La cornice a scatto è di tipo click-clack per una facile sostituzione del messaggio. Le cornici sono disponibili in diversi formati, profilo da 25 mm, fondo in plastica e protezione in pvc antiriflesso, disponibili sia ad angolo tondo che ad angolo vivo e possono essere montate in orizzontale e in verticale. Facile da assemblare, la struttura viene consegnata smontata. Ideale per uso interno.

- Altezza 200 cm
- Base Ø 30 cm
- Disponibile in varie configurazioni
- Le cornici possono essere montate sia in orizzontale che in verticale
- Profilo cornici 25 mm.
- Fornito smontato

Easy pole snap frame 2-way aluminium pole. Available with snap frame landscape or portrait.

Tutte le composizioni sono disponibili con cornici ad angolo tondo e vivo. Orientamento verticale o orizzontale. Monofacciale o Bifacciale. Disponibili portadepliant accessori.

Tutti i componenti Easy Pole a pag. 38



EASY POLE | SNAPFRAME

Cornici a scatto montate su palo Easy Pole.

- Disponibili con angolo tondo o angolo vivo
- Profilo 25 mm.
- Sistema klik-clak
- Orizzontale o verticale
- Monofacciale o bifacciale
- Fornito smontato
- Altezza Palo 200 cm.

- Self-supporting snap frame
- Available with round corner or mitred corner
- Profile 25 mm.
- Klik-clak system
- Landscape or portrait
- Single side or double side
- Unassembled
- Height Pole: 200 cm.

MITRED CORNER



ROUND CORNER



Componi la tua cornice autoportante con cornici e portadepliant.

Tutti i componenti Easy Pole a pag. 38

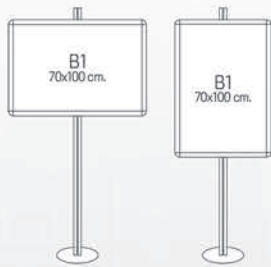

EASY POLE 71 - 1xB1 (70X100 cm.)
cod. 102710 ~ EASY POLE 71 MVR
cod. 102730 ~ EASY POLE 71 MOR

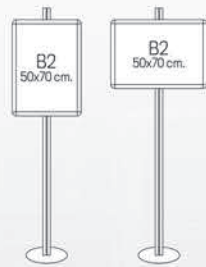

EASY POLE 57 - 1xB2 (50x70 cm.)
cod. 102750 ~ EASY POLE 57 MVR
cod. 102770 ~ EASY POLE 57 MOR

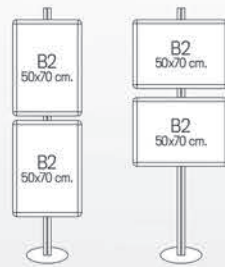

EASY POLE 57 D - 2xB2 (50x70 cm.)
cod. 102758 ~ EASY POLE 57-D MVR
cod. 102760 ~ EASY POLE 57-D MOR

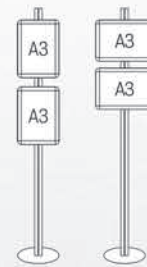

EASY POLE 23 - 2xA3 (29,7X42 cm.)
cod. 102790 ~ EASY POLE 23 MVR
cod. 102801 ~ EASY POLE 23 MOR

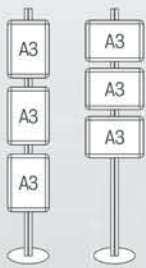

EASY POLE 33 - 3xA3 (29,7X42 cm.)
cod. 102880 ~ EASY POLE 33 MVR
cod. 102810 ~ EASY POLE 33 MOR

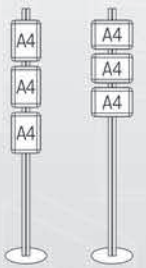

EASY POLE 34 - 3xA4 (29,7X42 cm.)
cod. 102820 ~ EASY POLE 34 MVR
cod. 102840 ~ EASY POLE 34 MOR

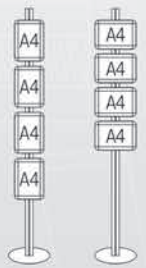

EASY POLE 44 - 4xA4 (29,7X42 cm.)
cod. 102900 ~ EASY POLE 44 MVR
cod. 102860 ~ EASY POLE 44 MOR



EASY POLE S230

Easy Pole S230 con applicate n° 1 cornice a scatto A3 angolo tondo orizzontale e n° 3 portadepliant A4 verticale.

Easy Pole S230

• N° 1 snap frame A3 round corner landscape • N° 3 brochure holder A4 portrait.

- 1x 102702 ~ EASY STAND BASE
- 1x 102703 ~ EASY STAND PROFILE
- 1x 102704 ~ EASY END CAP
- 1x 102682 ~ SNAP FRAME A3 - 25 mm.
- 3x 102493 ~ PORTADEPLIANT A4

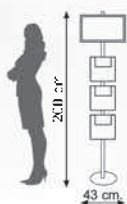

cod. 102911 ~ EASY POLE S230



EASY POLE STAND

Easy Pole Stand è composto da montante easy pole con applicata cornice Snap Frame A4 e portadepliant trasparente A4.

Easy Pole Stand is composed of easy pole with Snap Frame A4 and clear brochure holder A4.

- 1x 102702 ~ EASY STAND BASE
- 1x 102703 ~ EASY STAND PROFILE
- 1x 102704 ~ EASY END CAP
- 1x 102681 ~ SNAP FRAME A4 - 25 mm.
- 1x 102705 ~ EASY PLATE
- 1x 102675 ~ PLEXI POCKET A4

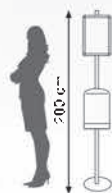

cod. 103001 ~ EASY POLE STAND



EASY POLE POKET

Easy Pole poket realizzato con pannello in alubond cm 150x50x0,3. n° 3 tasche poket A4 in metacrilato trasparente. Personalizzazione con adesivo prespaziato su richiesta.

Easy Pole Poket - alubond panel front side with n° 3 acrylic poket A4 landscape. On request is possible customize the panel with adhesive.

- 1x 102702 ~ EASY STAND BASE
- 1x 102703 ~ EASY STAND PROFILE
- 1x 102704 ~ EASY END CAP
- 1x 102510 ~ PANNELLO ALU BOND 150x50 cm
- 2x 102705 ~ EASY PLATE + VITE
- 2x 100491 ~ COPRIMITE - DOT 15mm
- 6x 100503 ~ SIDE - DISTANZIALE LATERALE
- 2x 104032 ~ TASCIA POKET A4 - ORIZ.
- 1x 104031 ~ TASCIA POKET A4 - VERT.



cod. 102912 ~ EASY POLE POKET



EASY POLE FIREMAN

Easy Pole fireman - struttura porta estintore completa di cornice A4 verticale e suo pittogramma. (Estintore non incluso).

Easy Pole fireman with A4 snap frame

- 1x 102702 ~ EASY STAND BASE
- 1x 102703 ~ EASY STAND PROFILE
- 1x 102704 ~ EASY END CAP
- 1x 102681 ~ SNAP FRAME A4 - 25 mm.
- 1x 102705 ~ EASY PLATE
- 1x 102707 ~ GANCIO ESTINTORE



cod. 102913 ~ EASY POLE FIREMAN





EASY POLE CH

Easy Pole Clear Holder è composto da montante easy pole con applicati 3, 4 o 6 portadepliant trasparenti A4.

- Palo: H.200 cm. - Base: Ø 30 cm.
- Portadepliant Plexi Pocket A4
- Fornito Smontato

Easy Pole Clear Holder is composed of easy pole with applied 3,4 or 6 clear brochure holder A4.

- cod. 103006 ~ EASY POLE CH 3x44 1)
- cod. 103007 ~ EASY POLE CH 4x44
- cod. 103008 ~ EASY POLE CH 6x44 2)



PLEXI POCKET A4

Portadepliant A4 in Acrilico Trasparente
Brochure holder A4. Clear

cod. 102675



SUGGESTION POLE

Struttura autoportante. Palo di sostegno a 2 vie in alluminio con base in ferro verniciato. Applicati alla struttura: 1 cornice a scatto in alluminio A4 e 1 Suggestion Box. Ideale per fiere, centri commerciali, uffici postali, banche, ecc.

- Palo: H.200 cm. - Base: Ø 30 cm.
- Cornice a scatto A4, profilo 25 mm.
- Suggestion Box: 22x11x29 cm.
- Fornito Smontato

Aluminium structure with iron bases. Applied 1x snap frame A4 and 1x Suggestion Box.

- Pole: H. 180 cm. - Base ø 30 cm.
- Snap Frame A4, 25 mm. profile
- Suggestion Box; 22x11x29 cm.
- Unassembled

cod. 102922 ~ SUGGESTION POLE



SUGGESTION BOX

Cassetta porta biglietti, card e suggerimenti
Box for suggestion card

cod. 106621



HALF SIDE POLE

Struttura autoportante composto palo di sostegno a 2 vie in alluminio con base in ferro verniciato. Applicata alla struttura 1 tasca laterale A3 trasparente.

- Palo: H.150 cm. - Base: Ø 30 cm.
- Tasca laterale A3 trasparente
- Fornito Smontato

Aluminium structure with iron bases. Applied 1x side pocket A3 (clear).

- Pole: H. 150 cm. - Base ø 30 cm.
- Side Pocket A3
- Unassembled

cod. 102923 ~ HALF SIDE POLE

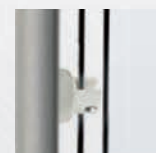

EASY NIPPER

Morsetto porta pannelli e tasche per palo Easy
Clamp for pocket/plates

cod. 102500 - 6,5 mm

cod. 102504 - 3,5 mm





EXHIBIT | CORNICI AUTOPORTANTI

Porta poster da pavimento. Exhibit è composto da un montante in alluminio a 2 vie, alto 120 cm, fissato su una base tonda in ferro verniciato a polvere. Apposte cornici a scatto di tipo click-clack per una facile sostituzione del messaggio. Cornice con profilo in alluminio da 25 mm, fondo in plastica e protezione in pvc antiriflesso. La struttura viene consegnata smontata. Ideale per uso interno.

- Altezza 120 cm.
- Disponibile in varie configurazioni
- Cornici disponibili con angolo vivo o tondo
- Le cornici possono essere montate in orizzontale o in verticale
- Fornito smontato

Exhibit snap frame 2-way aluminium pole. Available with snap frame landscape or portrait

MITRED CORNER



ROUND CORNER



Componi il tuo exhibit con cornici e portadepliant.

Tutti i componenti Exhibit a pag. 38

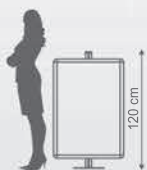

EXHIBIT 57 V ~ VERTICALE/ PORTRAIT (Mitred)

cod. 102962 ~ EXHIBIT 57 MVM - Single Side

cod. 102983 ~ EXHIBIT 57 BVM - Double Side

1

EXHIBIT 71 V ~ VERTICALE/ PORTRAIT (Round)

cod. 102963 ~ EXHIBIT 71 MVR - Single Side

cod. 102982 ~ EXHIBIT 71 BVR - Double Side

2



È POSSIBILE CONFIGURARE EXHIBIT CON TUTTE LE NOSTRE CORNICI A SCATTO. CON ANGOLO VIVO O TONDO, IN VERTICALE ED ORIZZONTALE, SIA MONO CHE BIFACCIALE

Richiedi quotazione

EASY POLE COMPONENTI

EASY STAND PROFILE



Montante/profilo in alluminio a 2 vie per Easy Pole. **H: 200 cm.**

cod. **102703** ~ EASY STAND PROFILE

Aluminium profile - 2 ways - for Easy Pole. **Length: 200 cm.**

EXHIBIT STAND PROFILE + EASY STAND BASE



Montante/profilo in alluminio a 2 vie per Exhibit. **H: 110 cm.** Comprensivo di "Easy Stand Base" **Ø: 30 cm.**

cod. **104400** ~ EXHIBIT STAND PROFILE + BASE

Aluminium stand profile - 2 ways - for Exhibit. **H: 110 cm.** "Easy Stand Base" **Ø: 30 cm.** Included

EASY STAND BASE



Easy Stand Base. Base in ferro per Easy Pole ed Exhibit. Verniciato colore grigio completo di n° 2 fori per il fissaggio sul profilo. Diametro 30 cm. 3,2 Kg.

cod. **102702** ~ EASY STAND BASE

Easy Stand Base. Iron base for Easy Pole and Exhibit. Gray painted with n° 2 holes for apply at aluminium profile. Diameter 30 cm. 3,2 Kg.

EASY END CAP



Easy End Cap. Tappo di chiusura in plastica per profilo Easy Stand Profile ed Exhibit Stand Profile.

cod. **102704** ~ EASY END CAP

Easy End Cap. End cap in plastic for Easy Stand Profile and Exhibit Stand Profile.

EASY PLATE



Piastra da utilizzare su Easy Pole ed Exhibit per applicare cornici e portadepliant. Completo di n° 1 vite.

cod. **102705** ~ EASY PLATE CON VITE

Plate for Easy Pole and Exhibit for apply snap frame and brochure holders. N° 1 screw included.



FRAME EASY POLE

Cornici a scatto per Easy Pole Complete di fori centrali, di Easy Plate e viti.

Snap frame for Easy Pole. Included Easy Plate and screw.

ANGOLO TONDO	Profilo
cod. 102681 ~ FRAME EASY POLE A4 - cm. 21x29,7	25 mm.
cod. 102682 ~ FRAME EASY POLE A3 - cm. 42x29,7	25 mm.
cod. 102683 ~ FRAME EASY POLE B2 - cm. 50x70	25 mm.
cod. 102684 ~ FRAME EASY POLE B1 - cm. 70x100	25 mm.

ANGOLO VIVO	Profilo
cod. 102691 ~ FRAME EASY POLE A4 - cm. 21x29,7	25 mm.
cod. 102692 ~ FRAME EASY POLE A3 - cm. 42x29,7	25 mm.
cod. 102693 ~ FRAME EASY POLE B2 - cm. 50x70	25 mm.
cod. 102694 ~ FRAME EASY POLE B1 - cm. 70x100	25 mm.

ROUND CORNER



MITRED CORNER



ACCESSORIO PORTADEPLIANT PLEXI A4

cod. **102675** ~ PLEXI POCKET A4
Easy Plate con vite NON incluso.



ACCESSORIO PORTADEPLIANT A4

cod. **102493** ~ WMBHA4 - EASY POLE
Completo di Easy Plate con vite.



ACCESSORIO PORTADEPLIANT A5

cod. **102492** ~ WMBHA5 - EASY POLE
Completo di Easy Plate con vite.



ACCESSORIO PORTADEPLIANT 1/3 di A4

cod. **102491** ~ WMBHDL - EASY POLE
Completo di Easy Plate con vite.



EASY NIPPER



Morsetto portapannelli fatti in alluminio per Easy Pole.

• Per spessori 3,5 e 6,5 mm.

cod. **102500** ~ 6,5 mm. (1pcs)

cod. **102504** ~ 3,5 mm. (1pcs)

Aluminium terminal board supporting.

• Thickness 3,5 and 6,5 mm.

ALUBOND PANEL

Pannello Alubond (Materiale composito alluminio). Dimensioni: cm. 150x50x0,3.

cod. **102510**

Alubond Panel (Aluminium composite material). Sizes: cm. 150x50x0,3

ALTRE DIMENSIONI DISPONIBILI SU RICHIESTA



CROSS POLE PRIME

Struttura autoportante. Doppio palo di sostegno a 2 vie con basi in ferro verniciato e traverse. Realizzato in alluminio. Cornice a scatto in alluminio, disponibili 70x100 o 100x140 cm con angolo tondo.

- Pali: H.200 cm. - Basi: Ø.30 cm.
- Cornici a scatto, profilo 25 mm.
- Fornito Smontato

Aluminium structure with iron bases. Applied 1x snap frame.

- Snap frame profile 25 mm.
- 2x) Pole: H.180 cm. - 2x) Base: Ø.30 cm.
- Unassembled

SU RICHIESTA È POSSIBILE COMPORRE IL PRODOTTO CON CORNICI AD ANGOLO VIVO E/O BIFACCIALE.

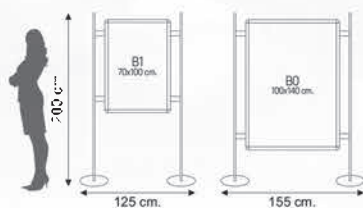

cod. 102914 ~ CROSS POLE PRIME 70x100

cod. 102915 ~ CROSS POLE PRIME 100x140 *

*Costi di imballaggio per cornici 100x140 cm.

*Packing cost for snap frames 100x140 cm.

cod. 100020 ~ PACKING COST *



CROSS POLE BANNER

Struttura autoportante composta da palo in alluminio a 2 vie con base in ferro verniciato. Traverso in alluminio su cui viene posizionato il banner. Montati sul palo 3 portadepliant A4 obliqui, trasparenti.

- Palo: H.200 cm. - Base: Ø.30 cm.
- Traverso per banner: 60x5x2,5 cm.
- Fornito Smontato

Aluminium structure with iron base. Support for banner - 3x brochure holders.

- 2x) Pole: H.200 cm. - 2x) Base: Ø.30 cm.
- Cross profile for banner: 60x5x2,5 cm
- Unassembled.

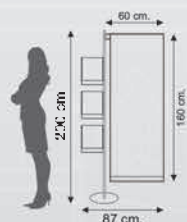

cod. 102916 ~ CROSS POLE BANNER





CROSS POLE | PLEXI POLE | WALLY

Struttura autoportante. Doppio palo di sostegno a 2 vie in alluminio con basi in ferro verniciato e traverse. Cornice a scatto in alluminio e 2 portadepliant A4 trasparenti a scelta tra 2 varianti. Disponibile con cornici 50x70 o 70x100 cm. con angolo vivo.

- Pali: H.200 cm. - Basi: Ø.30 cm.
- Cornici a scatto, profilo 25 mm.
- Fornito Smontato

Aluminium structure with iron bases. Applied 1x snap frame and 2x brochure holder A4.

- Snap frame profile 25 mm.
- 2x) Pole: H.200 cm. - 2x) Base: Ø.30 cm.
- Unassembled

SU RICHIESTA È POSSIBILE COMPORRE IL PRODOTTO CON CORNICI AD ANGOLO VIVO E/O BIFACCIALE.

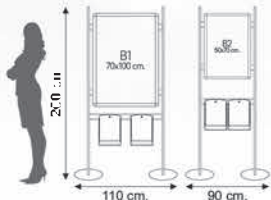

cod. **102920** ~ CROSS POLE PLEXI 50x70
cod. **102921** ~ CROSS POLE PLEXI 70x100

HOOKS POCKET A4

Portadepliant A4 in Acrilico Trasparente con ganci
Brochure holder A4. Clear with hooks.

cod. **102677**

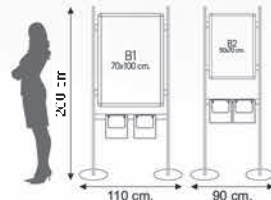

cod. **102917** ~ CROSS POLE WALLY 50x70
cod. **102918** ~ CROSS POLE WALLY 70x100

WMBHA4 EASY

Portadepliant A4 in Acrilico Trasparente
Brochure holder A4. Clear.

cod. **102493**



INFO STAND

Struttura espositiva monofacciale. Doppio tubolare di sostegno, traversi e ampia base rettangolare. Cornice in alluminio con profilo da 32 mm, angoli tondi. Protezione antiriflesso in PVC. cm 60x160.

- Formato 60x160 cm.
- Monofacciale
- Cornice profilo 32 mm.
- Su richiesta disponibile bifacciale

- Single sided
- Profile 32 mm. - Roun Corner
- PVC cover
- Available 60x160 cm.
- On request double sided available

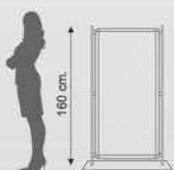

cod. **103500** ~ INFO STAND 60x160



ARK POLE | CORNICI AUTOPORTANTI



The new iMac
Performance and design. Taken right to the edge.

Struttura espositiva Ark Pole composta da palo e cornici a scatto. Montante a 4 vie in alluminio a base larga. Base con zavorra in ferro e copribase in ferro verniciato grigio. Facilmente componibile Ark Pole può essere configurato in tanti modi diversi. Ideale per cornici di grande formato e per zone particolarmente affollate. Le cornici sono disponibili in diversi formati, profilo da 25 mm, fondo in plastica e protezione in pvc antiriflesso, disponibili sia ad angolo tondo che ad angolo vivo e possono essere montate in orizzontale e in verticale. Facile da assemblare, la struttura viene consegnata smontata. Ideale per uso interno.

- Altezza 180 cm
- Base Ø 40 cm
- Disponibile in varie configurazioni
- Le cornici possono essere montate sia in orizzontale che in verticale
- Profilo cornici 32 mm.
- Fornito smontato

Ark Pole - 4 way aluminium pole extrusion with round iron base.

- Available on different configurations
- Snap frames are available landscape or portrait

Tutte le composizioni sono disponibili con cornici ad angolo tondo e vivo. Orientamento verticale o orizzontale. Monofacciale o Bifacciale. Disponibili portadepliant accessori.

Tutti i componenti Ark Pole a pag. 47



ARK POLE | SNAPFRAME

Cornici a scatto montate su palo Ark Pole.

- Disponibili con angolo tondo o angolo vivo
 - Profilo 25 mm.
 - Sistema clik-clak
 - Orizzontale o verticale
 - Monofacciale o bifacciale
 - Fornito smontato
 - Altezza Palo 180 cm.
- Self-supporting snap frame
 - Available with round corner or mitred corner
 - Profile 25 mm.
 - Klik-clak system
 - Landscape or portrait
 - Single side or double side
 - Unassembled
 - Height Pole: 180 cm.

MITRED CORNER



ROUND CORNER



Componi la tua cornice autoportante con cornici e portadepliant.

Tutti i componenti Ark Pole a pag. 47

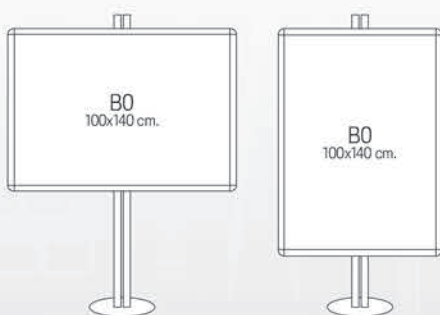
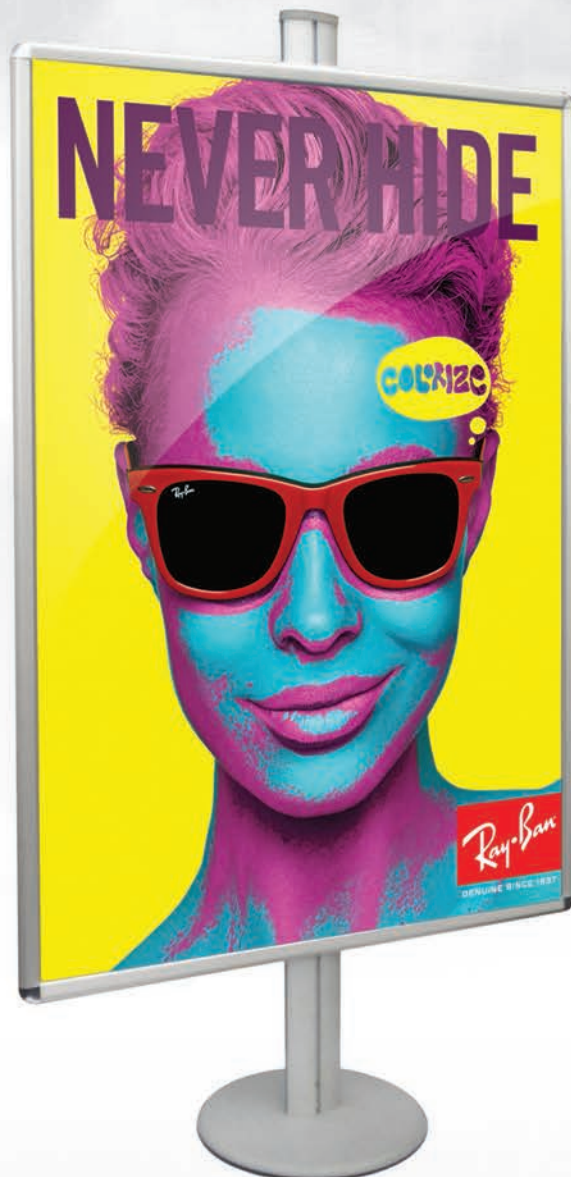

ARK POLE 14 - 1xB0 (100x140 cm.)

cod. **102101** ~ ARK POLE 14 MVR *

cod. **102111** ~ ARK POLE 14 MOR *

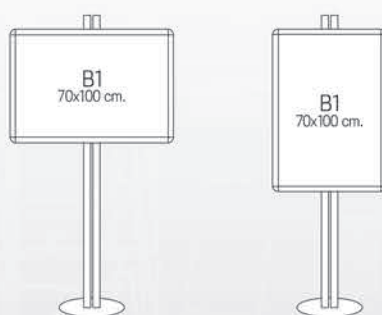

ARK POLE 71 - 1xB1 (70x100 cm.)

cod. **102201** ~ ARK POLE 71 MVR *

cod. **102211** ~ ARK POLE 71 MOR *

*Costi di imballaggio per cornici 100x140 cm.

*Packing cost for snap frames 100x140 cm.

cod. **100020** ~ PACKING COST *

PLEXI POCKET A4

Portadepliant A4 in Acrilico Trasparente
Brochure holder A4. Clear

cod. **102675**



SIDEWARD POCKET A4

Portadepliant A4 laterale in Acrilico Trasparente
Brochure holder A4. Clear

cod. **102676**



IRON POCKET 2xA4

Portadepliant 2xA4 in ferro verniciato
Brochure holder 2xA4. Iron

cod. **102708**





ARK POLE TRAVEL

Ark Pole Travel, con tasche A4 verticale in metacrilato trasparente
Tasche bifacciali.

Ark Pole with applied clear pocket A4 portrait.

- 1x 105001 ~ ARK POLE
- 12x 102498 ~ NIPPER 3 mm.
- 6x 102520 ~ TASCIA POKET TRAVEL
- A4 VERTICALE

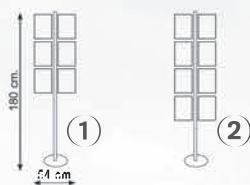

cod. 102464 ~ ARK POLE TRAVEL 6x A4 (1)

cod. 102465 ~ ARK POLE TRAVEL 8x A4 (2)



WMBH ARK

Portadepliant in Acrilico Trasparente. A5-A4-1/3A4
Brochure holder . Clear.
A5-A4-1/3A4

cod. 102494 - DL

cod. 102495 - A5

cod. 102496 - A4



ARK NIPPER

Morsetto porta pannelli e tasche per palo Ark
Clamp for pocket/plates

cod. 102498 - 3,5 mm

cod. 102499 - 6,5 mm



POKET TRAVEL

Portawisi A4 Verticale in Acrilico Trasparente
Leaflet holder A4. Clear. Portrait

cod. 102520



ARK POLE ESTATE

Ark Pole Estate, con tasche A4 orizzontali in metacrilato trasparente.
Tasche bifacciali.

Ark Pole with applied clear pocket A4 landscape.

- 1x 105001 ~ ARK POLE
- 12x 102498 ~ NIPPER 3 mm.
- 6x 102521 ~ TASCIA POKET ESTATE
- A4 ORIZZONTALE

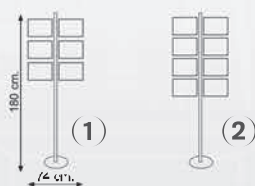

cod. 102466 ~ ARK POLE ESTATE 6x A4 (1)

cod. 102467 ~ ARK POLE ESTATE 8x A4 (2)



WMBH ARK

Portadepliant in Acrilico Trasparente. A5-A4-1/3A4
Brochure holder . Clear.
A5-A4-1/3A4

cod. 102494 - DL

cod. 102495 - A5

cod. 102496 - A4



ARK NIPPER

Morsetto porta pannelli e tasche per palo Ark
Clamp for pocket/plates

cod. 102498 - 3,5 mm

cod. 102499 - 6,5 mm



POKET ESTATE

Portawisi A4 Orizzontale in Acrilico Trasparente
Leaflet holder A4. Clear. Landscape

cod. 102521



PLEXI POCKET A4

Portadepliant A4 in Acrilico Trasparente
Brochure holder A4. Clear

cod. 102675



SIDEWARD POCKET A4

Portadepliant A4 laterale in Acrilico Trasparente
Brochure holder A4. Clear

cod. 102676



IRON POCKET 2x A4

Portadepliant 2XA4 in ferro verniciato
Brochure holder 2x A4. Iron

cod. 102708





ARK POLE | TEKNO

Struttura portadepliant autoportante. Il prodotto è composto da pannello in ALU-BOND da 3 mm. con applicati profili in alluminio e tasche portadepliant A4. Su richiesta è possibile personalizzare il pannello con adesivo prespaziato.

Free standing leaflet dispensers A4, ALU3B panel 3 mm. thickness with aluminium profile and A4 brochure holder. On request is possible customize the panel with adhesive.

cod. 102461 ~ ARK POLE TEKNO 6x44

①

cod. 102462 ~ ARK POLE TEKNO 8x44

②



cod. 104511 ~ TASCA TEKNO A4

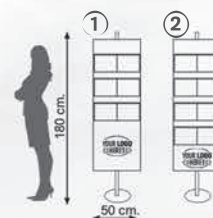

ARK POLE | CUBE

Struttura portaoggetti autoportante. Il prodotto è composto da montante in alluminio con base in ferro e 3 cubi portaoggetti. I cubi realizzati in metacrilato trasparente possono essere posizionati in altezza a scelta.

free standing storage - iron base, aluminium pole with n° 3 cubes compartments - the cubes made of trasparent acrylic can be positioned at height of your choice.

cod. 102463 ~ ARK POLE CUBE ~ CLEAR/TRANSPARENT CUBE



cod. 102501 ~ CUBE ~ CLEAR/TRANSP.



cod. 102502 ~ CUBE ~ WHITE/BIANCO



cod. 102503 ~ CUBE ~ BLACK/NERO

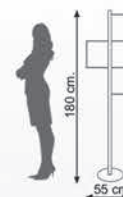
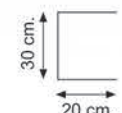

BISIDE | STAND

Struttura espositiva bifacciale. Costituita da doppio tubolare di sostegno, ampia base e 2 cornici a scatto in alluminio con profilo da 20 mm. ad angoli tondi. Protezione antiriflesso in PVC. Disponibile 70x100 e 100x140 cm.

- Double sided
- 2x Snap Frame
- Profile 20 mm. - Roun Corner
- PVC cover
- Available 70x100 and 100x140 cm.

cod. 102469 ~ BISIDE STAND 70X100 cm.

cod. 102470 ~ BISIDE STAND 100X140 cm.

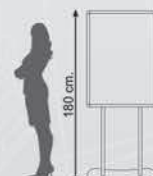
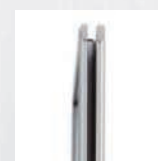



ARK | cPOLE

- Cornice autoportante
cm. 50x70 o cm. 70x100
- Profilo 25 mm.
- Cornice fornita ad angolo vivo (ang. tondo su richiesta)
- Disponibile con 2 o 4 portadepliant
- Fornito smontato
- Self-supporting frame
cm. 50x70 or cm. 70X100
- Profile 25 mm.
- Snap frame mitred corner
- Available with 2 or 4 brochure holders
- Unassembled

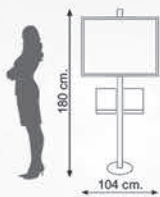

ARK cPOLE ~ 70x100

cod. 102232 ~ 2 BROCHURE HOLDER

cod. 102234 ~ 4 BROCHURE HOLDER

①

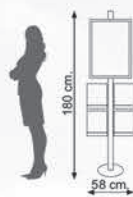

ARK cPOLE ~ 50x70

cod. 102231 ~ 2 BROCHURE HOLDER

cod. 102233 ~ 4 BROCHURE HOLDER



ARK | iPOLE

Ark Pole Iron Holder è composto da montante ark pole con applicati n° 3, 4 o 6 portadepliant in ferro 2xA4.

Ark Pole Iron Holder is composed of ark pole with applied 3, 4 or 6 iron brochure holder 2xA4.

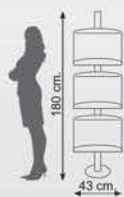

cod. 102224 ~ ARK iPOLE 3x2A4 (SINGLE SIDE)

cod. 102225 ~ ARK iPOLE 4x2A4 (DOUBLE SIDE)

cod. 102226 ~ ARK iPOLE 6x2A4 (DOUBLE SIDE)

①

②

③





ARK POLE CRUISE

Struttura autoportante composta da 2 Ark Pole comprensivi di basi, traversi in alluminio. Applicata alla struttura cornice a scatto in alluminio Disponibile con cornici 70x100 o 100x140 cm. con angolo tondo.

- Pali: H.180 cm. - Basi: Ø.40 cm.
- Cornici a scatto, prof. 32 mm, Ang. Tondo

Aluminium structure with iron bases. Applied 1x snap frame.

- Snap frame, prof. 32 mm. Round Corner
- 2x) Ark Pole: H.180 cm. - 2x) Base: Ø.40 cm.

SU RICHIESTA È POSSIBILE COMPORRE IL PRODOTTO CON CORNICI AD ANGOLO VIVO E/O BIFACCIALE.

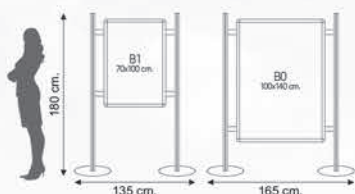

cod. 102090 ~ ARK POLE CRUISE 70x100 *

cod. 102091 ~ ARK POLE CRUISE 100x140 *

*Costi di imballaggio per cornici 100x140 cm.

*Packing cost for snap frames 100x140 cm.

cod. 100020 ~ PACKING COST *



ARK POLE SIGN

Struttura autoportante composta da Ark Pole comprensivo di basi con applicati alla struttura elementi di segnaletica a bandiera "Flag Alu Sign" cm. 15x40. Altezza regolabile. Ideali per alberghi, fiere, centri commerciali.

- Palo: H.180 cm. - Base: Ø.40 cm.
- Moduli cm. 15x40, regolabili in altezza. 4 pz. inclusi
- Segnaletica bifacciale

- Ark Pole: H.180 cm. - Base: Ø.40 cm.
- Flag Sign: cm. 15x40, adjustable height. 4 pcs. included
- Flag sign double sided

SU RICHIESTA È POSSIBILE COMPORRE IL PRODOTTO CON CORNICI AD ANGOLO VIVO E/O BIFACCIALE.



cod. 102092 ~ ARK POLE SIGN - 4 MODULI cm. 15x40



FLAG ALU SIGN 15x40

Segnaletica a bandiera in alluminio. cm. 15x40
Flag aluminum signage. cm 15x40

cod. 101365



• MODULO 15x40 cm.
FLAG ALU SIGN
4 pz. inclusi

ARK POLE COMPONENTI

ARK POLE PROFILE + ARK POLE BASE

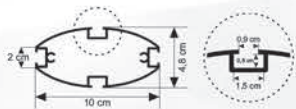

- Montante in alluminio a 4 vie (Ark Pole Profile). Tappo incluso
- Base in ferro colore grigio

- Palo: H.180x10x4,8 cm. ca.
- Base: Ø.40xH.3 cm. ca.
- Peso: Kg 9 ca.

cod. **105001** ~ ARK POLE (PROFILE+BASE)

- Aluminium profile 4 way (Ark Pole Profile). End cap included
- Iron Base grey painted

- Pole: H.180x10x4,8 cm. ca.
- Base: Ø.40xH.3 cm. ca.
- Weight: Kg 9 ca.

ARK PLATE

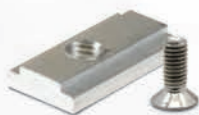

Piastra da utilizzare su Ark Pole per applicare cornici e portadepliant. Completo di n° 1 vite.

cod. **103506** ~ ARK PLATE CON VITE

Plate for Ark Pole for apply snap frame and brochure holders. N° 1 screw included.

Morsetto portapannelli in alluminio per Ark Pole.

- Disponibile per spessori 3,5 mm. e 6,5 mm.

cod. **102498** ~ ARK NIPPER 3,5 mm. (1pcs)

cod. **102499** ~ ARK NIPPER 6,5 mm. (1pcs)

Aluminium terminal board supporting.

- Available for thickness 3,5 mm and 6,5 mm.

ARK NIPPER



ALUBOND PANEL

Pannello Alubond (Materiale composito alluminio). Dimensioni: cm. 150x50x0,3.

cod. **102510**

Alubond Panel (Aluminium composite material). Sizes: cm. 150x50x0,3

ALTRE DIMENSIONI DISPONIBILI SU RICHIESTA

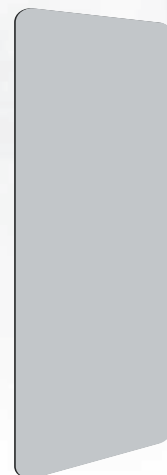

Frame Ark Pole

Cornici a scatto per Ark Pole Complete di fori centrali, di Ark Plate e viti.

Frame Ark Pole

Snap frame for Ark Pole. Included Ark Plate and screw.

ANGOLO TONDO	Profile
cod. 102471 ~ FRAME ARK POLE A4 - cm. 21x29,7	25 mm.
cod. 102472 ~ FRAME ARK POLE A3 - cm. 42x29,7	25 mm.
cod. 102473 ~ FRAME ARK POLE B2 - cm. 50x70	25 mm.
cod. 102474 ~ FRAME ARK POLE B1 - cm. 70x100	25 mm.
cod. 102475 ~ FRAME ARK POLE B0 - cm. 100x140	25 mm.
ANGOLO VIVO	Profile
cod. 102481 ~ FRAME ARK POLE A4 - cm. 21x29,7	25 mm.
cod. 102482 ~ FRAME ARK POLE A3 - cm. 42x29,7	25 mm.
cod. 102483 ~ FRAME ARK POLE B2 - cm. 50x70	25 mm.
cod. 102484 ~ FRAME ARK POLE B1 - cm. 70x100	25 mm.
cod. 102485 ~ FRAME ARK POLE B0 - cm. 100x140	25 mm.

ROUND CORNER



MITRED CORNER



ACCESSORIO PORTADEPLIANT A4

cod. **102496** ~ WMBHA4 - ARK POLE

Completo di Ark Plate con vite.



POKET TRAVEL

Portavisi A4 Verticale in Acrilico Trasparente Leaflet holder A4. Clear. Portrait

cod. **102520**



ACCESSORIO PORTADEPLIANT PLEXI A4

cod. **102675** ~ PLEXI POCKET A4

Ark Plate con vite NON incluso.



ACCESSORIO PORTADEPLIANT A5

cod. **102495** ~ WMBHA5 - ARK POLE

Completo di Ark Plate con vite.



ACCESSORIO PORTADEPLIANT LATERALE PLEXI A4

cod. **102676** ~ SIDEWARD POCKET A4

Ark Plate con vite NON incluso.



ACCESSORIO PORTADEPLIANT 1/3 di A4

cod. **102494** ~ WMBHDL - ARK POLE

Completo di Ark Plate con vite.



POKET ESTATE

Portavisi A4 Orizzontale in Acrilico Trasparente Leaflet holder A4. Clear. Landscape

cod. **102521**



ACCESSORIO PORTADEPLIANT FERRO 2XA4

cod. **102708** ~ IRON POCKET 2XA4

Ark Plate con vite NON incluso.





ARK BANNER

Sistema espositivo portastampe in alluminio. La stampa viene montata ai profili clik-clak. Struttura stabile e di grande impatto visivo. Per ambienti indoor ed esposizioni di lunga durata. Disponibile per stampe 80x200 cm. - 100x200 cm. 80x100 cm. - 100x100 cm.

- Montaggio veloce
- Sacca trasparente per il trasporto inclusa
- Stampa e supporto per la stampa NON inclusi

Display system in aluminium with clik-clak profile. Plastic bags included.

Available: 80x200 cm. - 100x200 cm. - 80x100 cm. 100x100 cm.

cod. 100111 ~ ARK BANNER 80x200

cod. 100113 ~ ARK BANNER SMALL 80x100

cod. 100112 ~ ARK BANNER 100x200

cod. 100114 ~ ARK BANNER SMALL 100x100

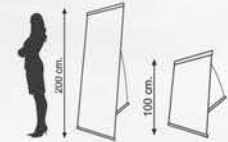

SPIDER PRO PORTA BANNER

Struttura portabanner. Realizzato in plastica. Soluzione efficace per esporre i vostri banner.

- Formato 100x200 cm
- Montaggio veloce
- Sacca per il trasporto inclusa
- Stampa e supporto per la stampa NON inclusi

- Print format 100x200 cm.
- Fast an easy set up
- Get your message up in 30 seconds
- Included nilon bag
- Media print NOT included

cod. 100094 ~ SPIDER PRO 100x200

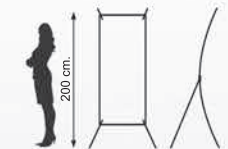
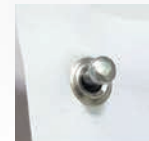

SPIDER PORTA BANNER

Struttura portabanner. Realizzata in plastica, economica ma efficace per esporre i vs banner.

- Formato 60x160 cm
- Montaggio veloce
- Supporti porta banner regolabili
- Sacca per il trasporto inclusa
- Stampa e supporto per la stampa NON inclusi

- Print format 60x160 cm.
- Fast an easy set up
- Get your message up in 30 seconds
- Included nilon bag
- Media print NOT included

cod. 100091 ~ SPIDER 60x160

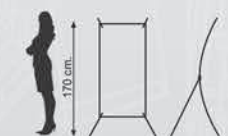
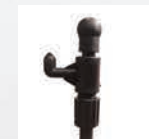

BACKPACK | ZAINO BANNER | PORTABANNER

Zaino rinforzato con sistema portabanner.
Tasca porta catalogo e portabottiglie.

- Formato Banner cm 50x100
- Peso 1,6 Kg (senza banner)
- Fornito Smontato
- Stampa e supporto per la stampa NON inclusi

Reinforced backpack for banner, with water bottle holders and catalog storage. Kg 1,6.

- Banner sizes cm 50x100
- Unassembled
- Weight 1,6 Kg



cod. 100090 ~ BACKPACK BANNER 100x60

MINI | X

Portabanner da tavolo. Realizzato in plastica.
Sistema ad X con agganci per la stampa.

- Mod. 1) stampa cm 23x41 ganci/piedini Azzurri.
- Mod. 2) stampa cm 21x29,7 ganci/piedini Cromo.
- Stampa e supporto per la stampa NON inclusi

- Mini X-Banner
- 2 sizes available

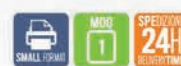

cod. 100096 ~ MINI X - A4 - 21x29,7 cm.

cod. 100095 ~ MINI X - 23x41 cm.

ROLLY | ROLLUP MINI

Mini roll up da banco monofacciale.

- 2 Formati disponibili A4 e A3
- Autoavvolgente.
- Confezionati singolarmente
- Stampa e supporto per la stampa NON inclusi

Mini roll up - available A4 and A3

- Fast an easy set up
- Media print NOT included



cod. 104321 ~ ROLLY A4 - (21x29,7 cm.)

cod. 104322 ~ ROLLY A3 - (29,7x42 cm.)

PEG | PIEDINO IN CARTONE

Piedino portapannelli. Realizzato in cartone.
Disponibile nel formato da cm. 27 (con foro) e nel formato da 60 cm.

- Realizzato in Cartone
- Formati disponibili H. 27 cm (con foro) e H. 60 cm

Foot board for panel display.
2 Sizes Available , H. 27 (with hole) and H. 60 cm.

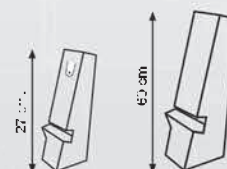

cod. 104303 ~ PEG CLASSIC-CARTON - 27 cm.

cod. 104306 ~ PEG CLASSIC-CARTON - 60 cm.



ROLLUP NEW MODEL 3

Roll Up **New Model 3**. Sistema espositivo portabanner autoavvolgente. La stampa (banner) viene fissata alla base con biadesivo (3M) e nella parte superiore è fissata al profilo grazie al sistema a scatto tipo click-clack.

- Piedini interamente in alluminio
- Aggancio con occhiello in plastica sull'asta
- Montaggio veloce
- Sacca per il trasporto inclusa
- Stampa e supporto per la stampa **NON** inclusi

- Plastic clip
- Clik-clak system
- Fast an easy set up
- Get your message up in 30 seconds
- Included nylon bag
- Media print NOT included



Code	Size	Base	Feet	Weight	Poster
cod. 107513	80 cm.	cm 9x9x81,5	cm 37x4,8	Kg 1,82 ca.	cm 80x200
cod. 107514	85 cm.	cm 9x9x86,5	cm 37x4,8	Kg 1,90 ca.	cm 85x200
cod. 107515	100 cm.	cm 9x9x101,5	cm 37x4,8	Kg 2,12 ca.	cm 100x200





ROLLUP MODEL 6

Roll Up Model 6. Sistema espositivo portabanner autoavvolgente. La stampa (banner) viene fissata alla base con biadesivo (3M) e nella parte superiore è fissata al profilo grazie al sistema a scatto tipo click-clack.

L'asta di supporto verticale è bloccata alla base dal pratico fermo in plastica con rinforzo in alluminio.

- Fianchetti e piedini neri
- Piastra in metallo sul fondo per maggiore stabilità.
- Aggancio con occhiello in plastica sull'asta
- Montaggio veloce
- Sacca per il trasporto inclusa
- Stampa e supporto per la stampa **NON** inclusi

- Plastic clip
- Clik-clak system
- Fast an easy set up
- Get your message up in 30 seconds
- Included nylon bag
- Media print NOT included



Code	Size	Base	Feet	Weight	Poster
cod. 107516	85 cm.	cm 9x8,5x86,5	cm 29,5x4,5	Kg 2,40 ca.	cm 85x200
cod. 107517	100 cm.	cm 9x8,5x101,5	cm 29,5x4,5	Kg 3,10 ca.	cm 100x200
cod. 107518	120 cm.	cm 9x8,5x121,5	cm 29,5x4,5	Kg 3,80 ca.	cm 120x200
cod. 107519	150 cm.	cm 9x8,5x151,5	cm 29,5x4,5	Kg 4,20 ca.	cm 150x200

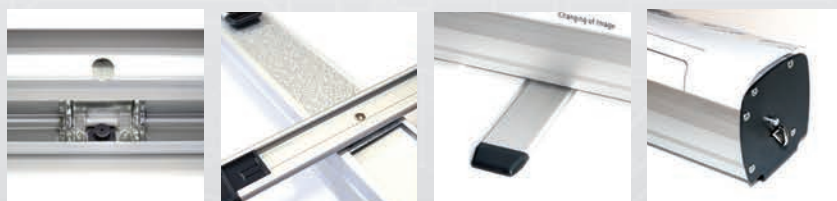



ROLLUP NEWMODEL 10

Roll Up New **Model 10**. Sistema espositivo portabanner autoavvolgente. La stampa (banner) viene ospitata nella base. Il banner viene fissato alla base con adesivo (3M) e nella parte superiore è fissato al profilo grazie al sistema a scatto tipo click-clack.

L'asta di supporto verticale è bloccata alla base dal pratico rinforzo in metallo.

- Piedini interamente in alluminio
- Aggancio in plastica sull'asta
- Montaggio veloce
- Imballati Singolarmente
- Sacca imbottita per il trasporto inclusa
- Stampa e supporto per la stampa **NON** inclusi

- Plastic eyelet
- Clik-clak system
- Fast an easy set up
- Get your message up in 30 seconds
- Included padded bag
- Media print NOT included



Code	Size	Base	Feet	Weight	Poster
cod. 100902	85 cm.	cm 9x9x81	cm 34x4,5	Kg 2,10 ca.	cm 85x200
cod. 100903	100 cm.	cm 9x9x101	cm 34x4,5	Kg 2,30 ca.	cm 100x200





ROLLUP MODEL 18

Roll Up Model 18. Sistema portabanner autoavvolgente. Struttura robusta in alluminio. Forme arrotondate e profilo a goccia cromato. Il banner viene fissato alla base con adesivo (3M) e nella parte superiore è fissato al profilo grazie al sistema a scatto tipo click-clack.

- Profili laterali cromati a goccia
- Aggancio in plastica sull'asta
- Montaggio veloce
- Sacca imbottita per il trasporto inclusa
- Stampa e supporto per la stampa NON inclusi

- Chromed drop profiles
- Plastic clip
- Clik-clak system
- Fast an easy set up
- Get your message up in 30 seconds
- Included padded bag
- Media print NOT included

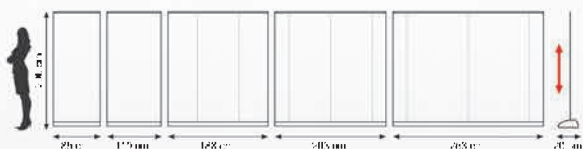

Code	Size	Base	Weight	Poster	N°. Support
cod. 100932	85 cm.	cm 20x8x88,5	Kg 2,70 ca.	cm 85x200	1
cod. 100933	100 cm.	cm 20x8x103	Kg 2,90 ca.	cm 100x200	1
cod. 100946	180 cm.	cm 20x8x183	Kg 5,50 ca.	cm 180x200	2
cod. 100947	200 cm.	cm 20x8x203	Kg 6,40 ca.	cm 200x200	3
cod. 100948	250 cm.	cm 20x8x253	Kg 7,80 ca.	cm 250x200	3





NEW MODEL | 3



- 1,82 Kg 80 cm.
- 1,90 Kg 85 cm.
- 2,12 Kg 100 cm.



MODEL | 6

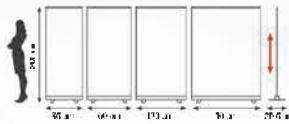
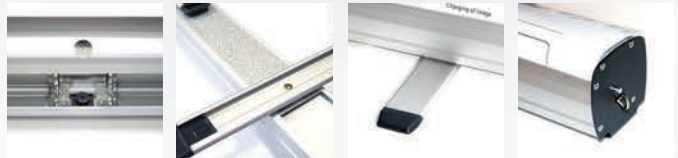

- 2,40 Kg 85 cm.
- 3,10 Kg 100 cm.
- 3,80 Kg 120 cm.
- 4,20 Kg 150 cm.



NEW MODEL | 10



- 2,10 Kg 85 cm.
- 2,30 Kg 100 cm.

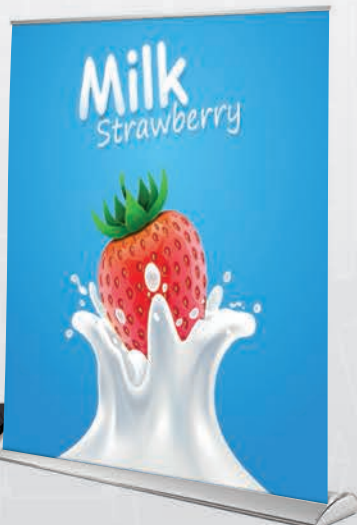

MODEL | 18



- 2,70 Kg 85 cm.
- 2,90 Kg 100 cm.
- 5,50 Kg 180 cm.
- 6,40 Kg 200 cm.
- 7,80 Kg 250 cm.



ROLLUP BIFACCIALE

Kg
4,30 Kg
85 cm.

Sistema espositivo portabanner autoavvolgente Bifacciale. Realizzato in alluminio satinato. Le stampa (banner) vengono fissate alla base con biadesivo (3M) mentre le parti superiori si fissano al profilo grazie al sistema a scatto tipo click-clack. Supporto con asta.

- Bifacciale
 - Aggancio in plastica sull'asta
 - Montaggio veloce
 - Sacca per il trasporto inclusa - cm 90x20x13
 - Stampa e supporto per la stampa NON inclusi
- Double Sided
 - Clik-clak system
 - Fast an easy set up
 - Get your message up in 30 seconds
 - Included nylon bag
 - Media print NOT included

cod. 100085 ~ ROLL UP BIFACCIALE ~ 85x200

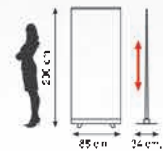

ASTA FLAG | TELESCOPICA

Asta telescopica per bandiere. Realizzata in alluminio. Completa di base zavorrata da riempire con acqua. Altezza massima 5 mt.

- Telescopica
 - 6 Occhielli
 - Altezza massima 5 mt.
 - Larghezza 110 cm.
 - Sacca per il trasporto inclusa
 - Stampa e supporto per la stampa NON inclusi
- Telescopic flag pole
 - Made of aluminium
 - Max. Height 5 mt.
 - Width 110 cm.
 - Base/ballast filling with water
 - Included nylon bag
 - Media print NOT included

cod. 105515 ~ ASTA FLAG TELESCOPICA





ASTA FLAG XS

Struttura per bandiera sia a goccia che a vela.
Ideale per uso esterno ed interno. Semplice da montare.

- Asta in alluminio e fibra di vetro
- Diametro Asta (alla base) est. 19 mm - int. 17 mm
- Montaggio semplice e veloce
- Stampa e supporto per la stampa NON inclusi

Flag, ideal for indoor and outdoor use.
Easy to assemble.

- Diameter (at base) ext. 19 mm - inn 17 mm
- Fast an easy set up
- Printed flag NOT included

cod. 105502 ~ FLAG XS - ASTA/ROD 200 cm

cod. 105569 ~ KIT FLAG XS - ASTA + BASE



DIME DISPONIBILI

per creare la tua bandiera.



BASE FERRO 30x18

- Ferro verniciato a polvere
- Dimensioni 30x18 cm
- Supporto per Asta cm. 7,7 x ø 1,65 ca.
- Peso: 2,30 Kg. ca.

cod. 105532



BASE IN PLASTICA

- Plastica - da riempire con acqua
- Dimensioni 45x45x11 cm
- Supporto per Asta cm. 7,7 x ø 1,65 ca.
- Peso: 0,65 Kg. ca.

cod. 105594



SOSTEGNO A VITE

- Plastica
- Dimensioni H. 53 (punta 23,71)x7,5 cm
- Supporto per Asta cm. 7,7 x ø 1,65 ca.
- Peso: 0,65 Kg. ca.

cod. 105591



PICCHETTO

- Ferro - col. cromo
- Dimensioni H. 60x1,2 cm
- Supporto per Asta cm. 7,7 x ø 1,65 ca.
- Peso: 0,90 Kg. ca.

cod. 105592



BASE PER RUOTA

- Ferro verniciato
- Dimensioni 58x22 cm
- Supporto per Asta cm. 7,7 x ø 1,65 ca.
- Peso: 0,65 Kg. ca.

cod. 105593



ASTE FLAG | S - M - L - XL

Strutture per bandiere sia a goccia che a vela.
Ideale per uso esterno ed interno. Semplice da montare.

- Asta in alluminio e fibra di vetro
- Diametro Asta S/M/L (alla base) est. 19 mm - int. 17 mm
XL (alla base) est. 25 mm - int. 17 mm
- Montaggio semplice e veloce
- Stampa e supporto per la stampa NON inclusi
- Piedistallo a X e Ciambella/Zavorra NON inclusi
- Taglie Disponibili: S - M - L - XL

Flag, ideal for indoor and outdoor use.
Easy to assemble.

- Diameter S/M/L (at base) ext. 19 mm - inn 17 mm
XL S/M/L (at base) ext. 25 mm - inn 17 mm
- Fast an easy set up
- Printed flag NOT included
- Metal Base and Ballast NOT included
- Available sizes: S - M - L - XL



cod. **105503** ~ FLAG **S** - ASTA/ROD 275 cm.

cod. **105504** ~ FLAG **M** - ASTA/ROD 340 cm.

cod. **105505** ~ FLAG **L** - ASTA/ROD 448 cm.

cod. **105506** ~ FLAG **XL** - ASTA/ROD 560 cm. *

DIME DISPONIBILI

per creare la tua bandiera.



SACCA TRASPORTO

- Nylon
- Divisione in scomparti

cod. **105566** - S/M 92x22 cm

cod. **105566** - L/XL 122x22 cm



ZAVORRA ACQUA

- Plastica
- Diametro 50 cm
- da riempire con Acqua
- Colore Argento

cod. **105561**



ZAVORRA SABBIA

- Tessuto plastificato
- Diametro 43 cm
- da riempire con Sabbia
- Colore Nero

cod. **105562**



BASE X

- Ferro verniciato a polvere
- Larghezza 82 cm
- Supporto per Asta cm. 7,7 x ø 1,65 ca.
- Peso: 2,30 Kg. ca.

cod. **105531**



BASE IN PLASTICA

- Plastica - da riempire con acqua
- Dimensioni 45x45x11 cm
- Supporto per Asta cm. 7,7 x ø 1,65 ca.
- Peso: 0,65 Kg. ca.

cod. **105594**



SOSTEGNO A VITE

- Plastica
- Dimensioni H. 53 (punta 23,7) x 7,5 cm
- Supporto per Asta cm. 7,7 x ø 1,65 ca.
- Peso: 0,65 Kg. ca.

cod. **105591**



PICCHETTO

- Ferro - col. cromo
- Dimensioni H. 60x1,2 cm
- Supporto per Asta cm. 7,7 x ø 1,65 ca.
- Peso: 0,90 Kg. ca.

cod. **105592**



BASE PER RUOTA

- Ferro verniciato
- Dimensioni 58x22 cm
- Supporto per Asta cm. 7,7 x ø 1,65 ca.
- Peso: 0,65 Kg. ca.

cod. **105593**

* PER IL MODELLO **XL** SI CONSIGLIA L'UTILIZZO DI ALMENO 2 ZAVORRE



ASTE FLAG SQUADRATE

Strutture per bandiere rettangolari, realizzate in alluminio, con sistema ad innesto. Ideale per uso esterno ed interno. Semplici da montare. Disponibili in 3 dimensioni: cm. 250x80 - cm. 350x80 - cm. 450x80.

- Asta in alluminio
- Diametro tubolari 25 mm.
- Diametro foro per montaggio base 17 mm
- Montaggio semplice e veloce
- Stampa e supporto per la stampa NON inclusi
- Piedistallo a X e Ciambella/Zavorra NON inclusi

Squared Flags, ideal for indoor and outdoor use. Easy to assemble. Available 3 sizes: cm. 250x80 - cm. 350x80 - cm. 450x80.

- Aluminum
- Diameter 25 mm
- Hole for base support 17 mm
- Fast an easy set up
- Printed flag NOT included
- Metal Base and Ballast NOT included



cod. 105511 ~ ASTA RETTANGOLARE - 250 cm

cod. 105512 ~ ASTA RETTANGOLARE - 350 cm

cod. 105513 ~ ASTA RETTANGOLARE - 450 cm

DIME DISPONIBILI
per creare la tua bandiera.



SACCA TRASPORTO

- Nylon
- Dimensioni 122x22 cm (chiuso)
- Divisione in scomparti

cod. 105566 - L/XL 122x22 cm



ZAVORRA ACQUA

- Plastica
- Diametro 50 cm
- da riempire con Acqua
- Colore Argento

cod. 105561



ZAVORRA SABBIA

- Tessuto plastificato
- Diametro 43 cm
- da riempire con Sabbia
- Colore Nero

cod. 105562



BASE X

- Ferro verniciato a polvere
- Larghezza 82 cm
- Supporto per Asta cm. 7,7 x ø 1,65 ca.
- Peso: 2,30 Kg. ca.

cod. 105531



BASE IN PLASTICA

- Plastica - da riempire con acqua
- Dimensioni 45x45x11 cm
- Supporto per Asta cm. 7,7 x ø 1,65 ca.
- Peso: 0,65 Kg. ca.

cod. 105594



SOSTEGNO A VITE

- Plastica
- Dimensioni H. 53 (punta 23,7) x 7,5 cm
- Supporto per Asta cm. 7,7 x ø 1,65 ca.
- Peso: 0,65 Kg. ca.

cod. 105591



PICCHETTO

- Ferro - col. cromo
- Dimensioni H. 60x1,2 cm
- Supporto per Asta cm. 7,7 x ø 1,65 ca.
- Peso: 0,90 Kg. ca.

cod. 105592



BASE PER RUOTA

- Ferro verniciato
- Dimensioni 58x22 cm
- Supporto per Asta cm. 7,7 x ø 1,65 ca.
- Peso: 0,65 Kg. ca.

cod. 105593

FLAG XS

cod. 105502 ~ FLAG XS

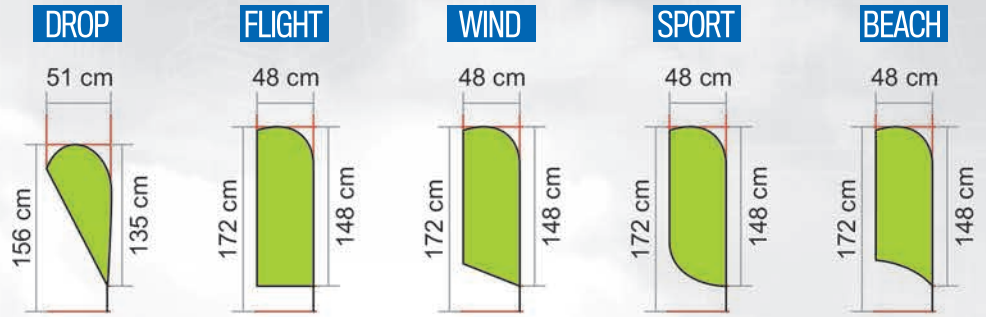

FLAG S

cod. 105503 ~ FLAG S



FLAG M

cod. 105504 ~ FLAG M

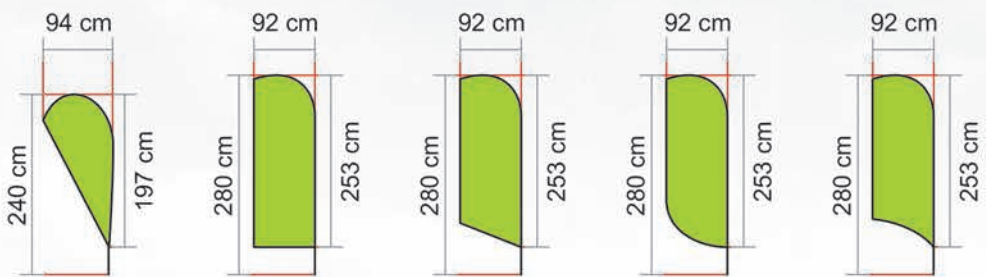

FLAG L

cod. 105505 ~ FLAG L

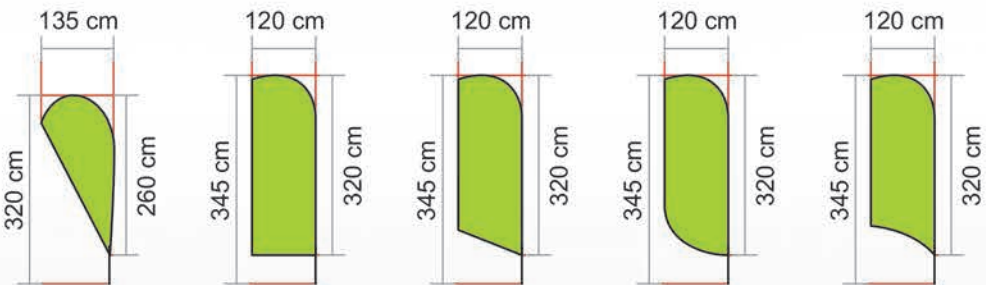

FLAG XL

cod. 105506 ~ FLAG XL

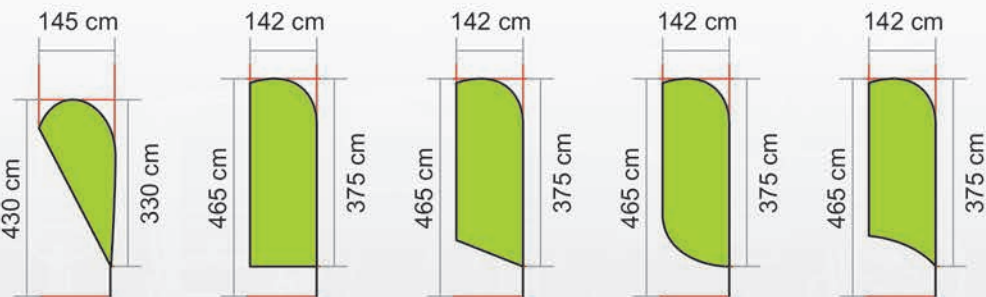

BANDIERE SQUADRATE

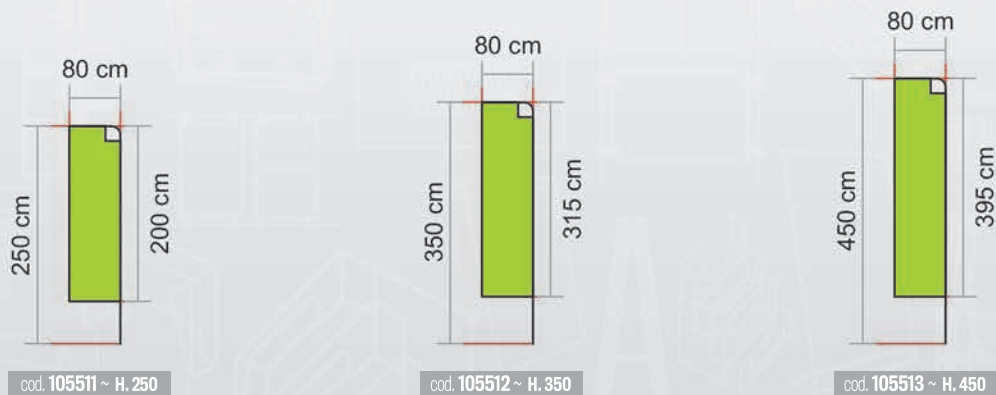

cod. 105511 ~ H. 250

cod. 105512 ~ H. 350

cod. 105513 ~ H. 450



SLANT | SUPPORTO BANDIERE

Supporto inclinato per bandiere. Fornisce adeguato supporto e stabilità. Adatto per poter esporre bandiere all'interno ed all'esterno su pareti, balconi o strutture. Realizzato in ferro colore cromo.

Stand for flags. A good solution for indoor and outdoor wall flags. Made in iron chrome finiture.

cod. 105571 ~ SLANT
cod. 105502 ~ FLAG XS - ASTA ROD 200 cm
cod. 105503 ~ FLAG S - ASTA ROD 275 cm
cod. 105504 ~ FLAG M - ASTA ROD 340 cm
cod. 105505 ~ FLAG L - ASTA ROD 448 cm

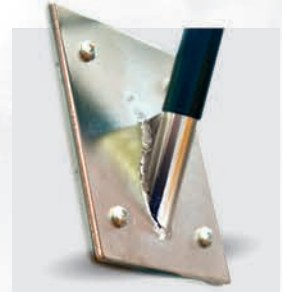
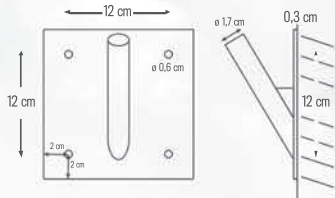

WALLEYE | OCCHIELLO DA PARETE

Occhiello da fissare alle pareti per il montaggio di striscioni, banner, ecc. Per interno ed esterno. Si monta con tasselli tirafondo (inclusi). Confezione 2x Wall Eye.

- Occhiello (interno): \varnothing cm 1.
- Tasselli Tirafondo cm 4 x \varnothing cm 1.
- Stampa e supporto di stampa **NON** inclusi

- 2 "Wall Eye" in box
- Eyelet (inside): \varnothing cm. 1
- Expandable fastener 4 cm. x \varnothing 1 cm.
- Print and support for print **NOT** included.

cod. **105572** ~ KIT WALL EYE - PARETE



POLEEYE | OCCHIELLO DA PALO

Occhiello da fissare a pali e pilastri per il montaggio di striscioni, banner, ecc. Per interno ed esterno. Si monta con fasce metalliche (incluse). Confezione 2x Pole Eye.

- Occhiello (interno): \varnothing cm. 1
- Fasce Fissaggio: cm. 120x1
- Stampa e supporto di stampa **NON** inclusi

- 2 "Wall Eye" in box
- Eyelet (inside): \varnothing cm 1.
- Ranger Fixing sizes: cm. 120x1
- Print and support for print **NOT** included.

cod. **105573** ~ KIT POLE EYE - PALO

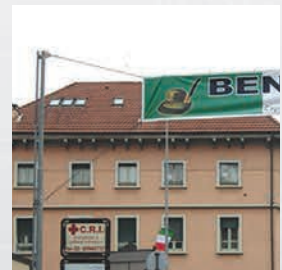



STREET FLAG

Una soluzione per l'esposizione di banner e bandiere istituzionali e personalizzate. Per interno ed esterno. I supporti per le aste si fissano a pali o strutture. Altezza variabile in base alla necessità. Aste realizzate in plastica, supporti e fasce in ferro.

- Dimensioni aste cm 68 x ø cm 2.
- Larghezza utile bandiera 61 cm
- Fasce Fissaggio in ferro: cm 120 x cm 1.
- Bandiera NON inclusa.

Flag side for street pole. The width of the flag is 61 cm, height is customizable instead. Rods made in plastic.

- Rods dimensions: 68 cm x ø 2 cm.
- Ranges Fixing dimensions: 120 cm x 1 cm.
- Flag NOT included.

cod. 105570 ~ KIT STREET FLAG



WALL STREET FLAG

Una soluzione per l'esposizione di banner e bandiere. Per interno ed esterno. I Supporti per le aste si fissano alle pareti con tasselli tirafondo. Aste realizzate in plastica e fibra di vetro piena. Supporti e tasselli tirafondo realizzati in metallo.

- Dimensioni aste cm 86,5 x ø cm 2.
- Tasselli Tirafondo cm 4 x ø cm 1.
- Bandiera NON inclusa.

Flag side for street pole. The width of the flag is 86,5 cm, height is customizable instead. Rods made in plastic and glass fiber.

Rods dimensions: 86,5 cm x ø 2 cm.
Expandable fastener sizes: 4 cm x ø 1 cm.
Flag NOT included.

cod. 105574 ~ KIT WALL STREET FLAG





BARRIER | STRUTTURA MODULARE

Il sistema Barrier è ideale per eventi sportivi e culturali, per mostre e musei. Garantisce l'ordine e la sicurezza in occasione di eventi. Flessibile e versatile, il concetto modulare lo rende facile da configurare. I connettori permettono di unire più strutture e formare barriere multiple. Non è solo funzionale, ma anche utile a sostenere il vostro messaggio pubblicitario.

- Struttura modulare in alluminio
- Dimensione Struttura 200x100 cm
- Diametro tubolari 2,5 cm
- Area di stampa (consigliata) 192x85 cm
- Le basi sono vendute separatamente
- Stampa e supporto per la stampa NON inclusi

The Barrier system it's the right idea for sports and cultural events, exhibitions, museums and parties. Barrier the new advertisement guide line.

- Modular structure
- Sizes Structur 200x100 cm
- Diameter 2,5 cm
- Print area 192x85 cm
- Bases are sold separately
- Print and support for print NOT included



cod. 105581 ~FRAME BARRIER - SOLO STRUTTURA - SENZA BASI

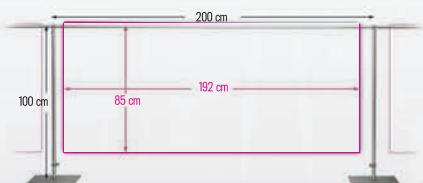

CONNECTOR T

Connettore a T. Per collegare più strutture "BARRIER FRAME" insieme.

cod. 105582



BASE FERRO 30x18

- Ferro verniciato a polvere
- Dimensioni 30x18 cm
- Supporto per Asta cm. 7,7 x ø 1,65 ca.
- Peso: 2,30 Kg. ca.

cod. 105532

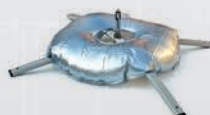

ZAVORRA ACQUA

- Plastica
- Diametro 50 cm
- da riempire con Acqua
- Colore Argento

cod. 105561



SACCA TRASPORTO

- Nylon
- Dimensioni 122x22 cm (chiuso)
- Divisione in scomparti

cod. 105566 - L/XL 122x22 cm



TENDI TELO

- Per tensionamento banner
- Lunghezza 16 cm
- Sfera o Gancio

cod. 50701 - TENDI TELO SFERA
cod. 50702 - TENDI TELO GANCIO



new FLAG|WALL

Struttura espositiva telescopica. Leggera e robusta. Fondali per fiere, sales point, ecc. Realizzata in alluminio plastica con piedi in ferro. Nero.

- Altezza da 89 a 237 cm
- Larghezza da 150 a 260 cm
- Montaggio Veloce
- Sacca per il trasporto incluso
- Stampa e supporti di stampa NON inclusi

- telescopic structure
- Height 89/237 cm
- Width 150/260 cm
- Fast an easy set up
- Get your message up in 30 seconds
- Included nylon bag
- Media print NOT included

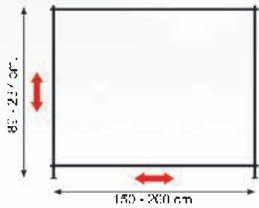

cod. 100131 ~ NEW FLAG WALL



FLAG|WALL extra

Versione rinforzata del New Flag Wall. Realizzata in alluminio plastica con piedi in ferro. Nero. + Robusta, + Stabile, + Affidabile

- Diametro Tubolari: 32, 35, 38 mm (Telescopici)
- Altezza da 95 a 230 cm
- Larghezza da 234 a 380 cm
- Montaggio Veloce
- Sacca per il trasporto incluso
- Stampa e supporti di stampa NON inclusi

- Diameter: 32,35, 38 mm (telescopic)
- Height 95/230 cm
- Width 234/380 cm
- Fast an easy set up
- Get your message up in 30 seconds
- Included nylon bag
- Media print NOT included

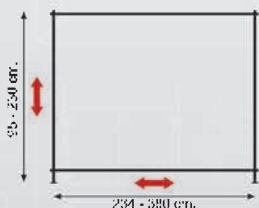

cod. 100132 ~ FLAG WALL EXTRA





WALL | VELCRO POPUP

Pop up per eccellenza, utilizzato come parete divisoria o per creare sfondi e stand in maniera rapida. Completamente ripiegabile il wall è realizzato in plastica e alluminio, la stampa viene applicata con il velcro. Struttura dritta completa di sacca per un facile trasporto.

- Dimensione di stampa cm. 228x228
- Peso 11,5 kg.
- Montaggio veloce con Velcro (incluso)
- Sacca per il trasporto inclusa
- Stampa e supporto per la stampa NON inclusi

- Print Area 228x228 cm
- Weight 11,5 kg
- Velcro Included
- Fast an easy set up
- Get your message up in 30 seconds
- Included nylon bag
- Media print NOT included

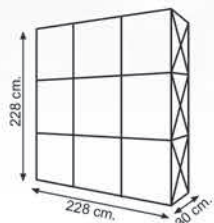

cod. 104435 ~ VELCRO WALL



VELCRO T | TAVOLO CON VELCRO

Velcro T. Tavolo promozionale per uso mobile. Struttura leggera facilmente smontabile. Realizzato in alluminio e plastica. Personalizzabile con Banner PVC da applicare alla struttura con il velcro (incluso).

- Struttura cm. b.79xh.80xp.30 ca.
- Piano cm 90,2x35x1,8
- Montaggio veloce
- Sacca per il trasporto incluso
- Stampa e supporto per la stampa NON inclusi

- Structure cm 79x80x30
- Top cm 90,2x35x1,8
- Fast an easy set up
- Included nylon bag
- Media print NOT included

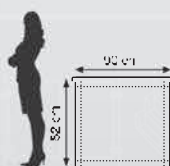

cod. 104440 ~ VELCRO T





SPRING POPUP POPWALL CURVO 3x3

Espositore Curvo Pop Up modulo 3x3. Monofacciale. Utilizzato come parete divisoria o per creare sfondi e stand. Completamente ripiegabile, realizzato in alluminio con aste in ferro, la stampa viene applicata con banda magnetica adesiva (inclusa). Comprensivo di Struttura, Pannelli semirigidi da 1 mm per la stampa (da rifilare dopo la stampa),

- Area Stampabile: H.230x350 cm ca. (con curve)
- Applicazione con banda magnetica (inclusa)
- Faretto inclusi
- Trolley per il trasporto incluso cm 42x43x88H.
- Supporti di stampa inclusi
- Stampa NON inclusa

The Spring Pop Wall is an extremely visible display system to present your product in large format.

- Magnetic
- Print Area H.230x350 cm
- Included trolley bag cm 42x43x88H.
- Media print included
- Print NOT included

cod. 104437 ~ SPRING POP WALL - CURVO 3x3

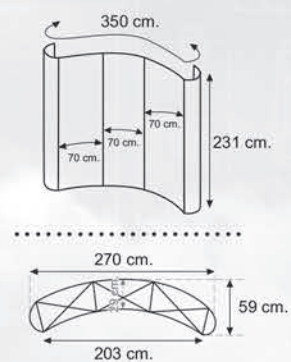

BE POP | TAVOLO POP UP

Tavolino Espositivo Pop Up. Completamente ripiegabile realizzato in alluminio e aste in ferro, la stampa sul pannello semirigido da 1 mm viene applicata con banda magnetica adesiva (inclusa). Struttura Curva.

- Dimensione Struttura: H.87x121x36 ca.
- Piano di appoggio 132x40x2 cm
- Area di stampa 214x85 cm. (Dopo rifilo)
- Montaggio veloce
- Sacca per il trasporto inclusa

- Structure cm H.87x121x36 ca.
- Top 132x40x2cm
- Fast an easy set up
- Included nylon bag
- Printed Area 214x85 cm. (after cutting)

cod. 104439 ~ BE POP - TAVOLO POP UP

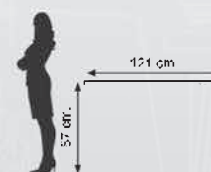



PANEL | DISPLAY

Sistema espositivo di facile trasporto. Grazie alle particolari cerniere il prodotto può assumere forme diverse. Il montaggio è semplice, basta far scivolare i pannelli (inclusi) all'interno dei profili e bloccare le viti. Può essere personalizzato con adesivo stampato.

- Dimensione cm. 260x200H. ca.
- Pannelli 60x90 cm
- Stampa NON inclusa

Exhibition system is a portable assembled panel construction. Slide the panels into the construction and lock it with screws.

- Size cm 260x200H.
- Panels: 60x90 cm.
- Print NOT included

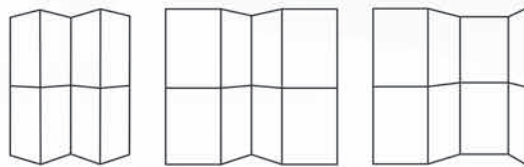
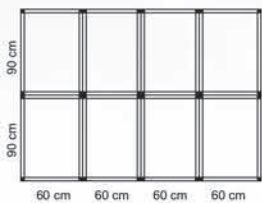

cod. 104441 ~ PANEL DISPLAY



SMART | TAVOLO PROMOZIONALE

Tavolo promozionale per uso mobile, facilmente smontabile. Struttura in metallo, pannelli e piano di appoggio realizzati in forex. Facilmente personalizzabile.

- Dimensioni H.85x76x37 ca - Top 80x40 cm
- Montaggio veloce
- Sacca per il trasporto incluso
- Stampa e supporto per la stampa NON inclusi

- Sizes cm H.85x76x37 - Top 80x40 cm
- Fast an easy set up
- Included nylon bag
- Carrying bags included
- Media print NOT included

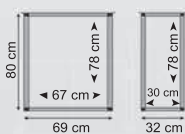

cod. 104430 ~ SMART - TAVOLO PROMOZIONALE





PROMO | TABLE

Tavolo promozionale per uso mobile, facilmente smontabile è dotato di sacca per il trasporto. Facilmente personalizzabile. Ripiano per sistemare cataloghi ed oggetti. Borsa per il trasporto in nylon inclusa. Ideale per punti vendita mobili, fiere e punti dimostrativi.

- Realizzato in PVC
- Montaggio veloce
- Sacca per il trasporto incluso
- Stampa per la stampa NON inclusi

Promotion tables for any trade show, traveling exhibit or in-store display. Made out of lightweight materials and assemble in 2 minutes without any tools. Carrying bags included.

- Made of PVC
- Fast and easy set up
- Included nylon bag
- Print NOT included

cod. 104431 ~ PROMO TABLE

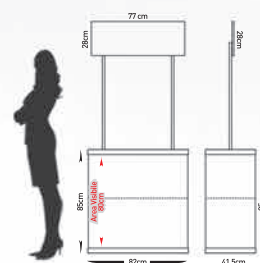

FABRIC | TAVOLO PROMOZIONALE

Tavolino promozionale trasportabile di gran classe. Realizzato con ripiano e base in legno color betulla. Pannello circolare in plastica extra strong, montaggio con velcro. Personalizzabile con adesivo. Ripiano in plastica. Completamente smontabile.

- Montaggio veloce
- 2 Sacche per il trasporto incluso
- Stampa e supporto per la stampa NON inclusi

Promotional table de-luxe. Made with shelf and wooden base.

- Fast and easy set up
- Included nylon bag
- Media print NOT included

cod. 104436 ~ FABRIC TABLE

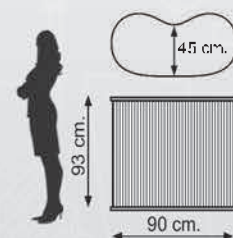

SEGNALETICA INTERNA DI **SICUREZZA**



Sistemi di segnaletica interna



Systems of internal signage



SNAP|SIGN

Costituite da 2 profili a scatto in alluminio, fondo in plastica e protezione in PVC trasparente. Si monta sia con tasselli che con biadesivo. Facile e veloce sostituzione del messaggio.

- Profili a scatto da 25 mm
- Vari formati disponibili

- 2 Aluminium snap profile
- Plastic pack panel
- Mounting with wall fixing or biadhesive
- Easy & quick poster change
- Many sizes available
- Aluminium Profile 25 mm.



SNAP SIGN	
cod. 101610	~ 100x50 mm.
cod. 101611	~ 148x50 mm.
cod. 101612	~ 86x55 mm.
cod. 101613	~ 200x100 mm.
cod. 101614	~ 297x100 mm.
cod. 101615	~ 155x155 mm.
cod. 101616	~ 170x160 mm.
cod. 101617	~ 170x120 mm.
cod. 101618	~ 200x200 mm.
cod. 101619	~ A6 148x100 mm.
cod. 101620	~ A5 210x148 mm.
cod. 101621	~ A4 297x210 mm.

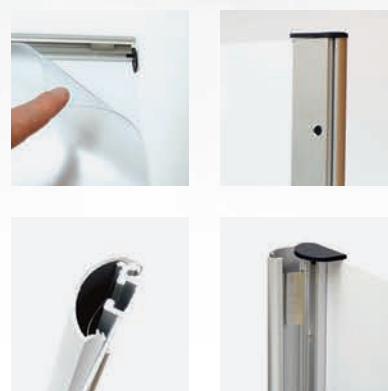
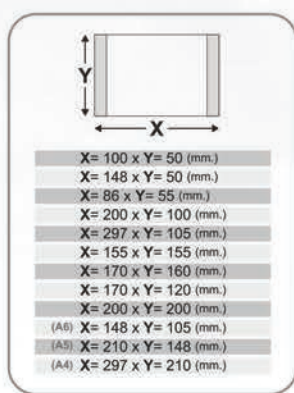

SQUARE|SIGN

Segnaletica su targhette in plexi trasparente. Applicabili con biadesivo (incluso). Ideali per uffici, alberghi, ristoranti e luoghi pubblici in genere.

- Disponibili 9 grafiche standard.
- Dimensione targhette 10x10 cm

STAMPE PERSONALIZZATE SU RICHIESTA

Signs on plates made of transparent plexi . Applicable with adhesive tape (included). Ideal for offices, hotels, restaurants and public places in general.

- Available 9 standard graphics
- Plates size 10x10 cm.

PERSONALISED PRINTS ON REQUEST

SQUARE SIGN	
1	cod. 101630 ~ UOMO
2	cod. 101631 ~ DONNA
3	cod. 101632 ~ UOMO DONNA
4	cod. 101633 ~ DISABILI
5	cod. 101634 ~ DIVIETO FUMO
6	cod. 101635 ~ DIVIETO ACCESSO
7	cod. 101636 ~ FREE WIFI
8	cod. 101637 ~ SPINGERE
9	cod. 101638 ~ TIRARE





ALUSIGN | SEGNALETICA DA PARETE

Sistemi di segnaletica di sicurezza realizzati in alluminio anodizzato con tappi terminali in plastica e protezione in pvc trasparente. Tutte le targhe possono essere utilizzate sia in verticale che in orizzontale.

- Profili disponibili cm 10 - 15 - 21
- Tappi terminali Grigi o Neri a scelta

Systems of safety signs made of aluminum. With plastic end caps available and clear PVC cover. All the signs can be used landscape or portrait.

- Profiles available cm 10 - 15 - 21
- End Cap Black or Grey



ALU SIGN 10 cm
cod. 101550 ~ 10/5 - cm. 10x5
cod. 101551 ~ 10/10 - cm. 10x10
cod. 101552 ~ 10/15 - cm. 10x15
cod. 101553 ~ 10/21 - cm. 10x21
cod. 101554 ~ 10/42 - cm. 10x42
cod. 101555 ~ 10/50 - cm. 10x50
cod. 101556 ~ 10/60 - cm. 10x60
cod. 101557 ~ 10/70 - cm. 10x70
cod. 101558 ~ 10/90 - cm. 10x90
cod. 101559 ~ 10/100 - cm. 10x100
cod. 101560 ~ 10/120 - cm. 10x120

PROFILO ALU SIGN 10 cm - 300 cm
cod. 101501 cm. 10x300

TAPPI TERMINALI END CAP 10 cm
cod. 101511 - Black - 1 pcs.
cod. 101516 - Grey - 1 pcs.

ALU SIGN 15 cm
cod. 101564 ~ 15/5 - cm. 15x5
cod. 101565 ~ 15/10 - cm. 15x10
cod. 101561 ~ 15/15 - cm. 15x15
cod. 101562 ~ 15/21 - cm. 15x21
cod. 101563 ~ 15/30 - cm. 15x30
cod. 101566 ~ 15/42 - cm. 15x42
cod. 101567 ~ 15/50 - cm. 15x50
cod. 101568 ~ 15/60 - cm. 15x60
cod. 101569 ~ 15/70 - cm. 15x70
cod. 101570 ~ 15/90 - cm. 15x90
cod. 101574 ~ 15/100 - cm. 15x100
cod. 101575 ~ 15/120 - cm. 15x120

PROFILO ALU SIGN 15 cm - 300 cm
cod. 101502 cm. 15x300

TAPPI TERMINALI END CAP 15 cm
cod. 101512 - Black - 1 pcs.
cod. 101517 - Grey - 1 pcs.

ALU SIGN 21 cm
cod. 101576 ~ 21/5 - cm. 21x5
cod. 101577 ~ 21/10 - cm. 21x10
cod. 101571 ~ 21/15 - cm. 21x15
cod. 101572 ~ 21/21 - cm. 21x21
cod. 101573 ~ 21/30 - cm. 21x30
cod. 101578 ~ 21/42 - cm. 21x42
cod. 101579 ~ 21/50 - cm. 21x50
cod. 101580 ~ 21/60 - cm. 21x60
cod. 101581 ~ 21/70 - cm. 21x70
cod. 101582 ~ 21/90 - cm. 21x90
cod. 101583 ~ 21/100 - cm. 21x100
cod. 101584 ~ 21/120 - cm. 21x120

PROFILO ALU SIGN 21 cm - 300 cm
cod. 101503 cm. 21x300

TAPPI TERMINALI END CAP 21 cm
cod. 101513 - Black - 1 pcs.
cod. 101518 - Grey - 1 pcs.



CUT SERVICE
 Servizio taglio su misura. Nessun ordine minimo richiesto.
 Cutting service. No minimum order required.
 cod. 2401 - STARTING COST
 cod. 2402 - CUT COST (EACH)



FLAG ALUSIGN | SEGNALETICA A BANDIERA

- Profilo cm 15
- Alluminio anodizzato
- Protezione PVC trasparente
- Tappi terminali in plastica Grigi o Neri a scelta
- Profile cm 15
- Anodized Aluminium
- Clear PVC cover
- Plastic End Cap Black or Grey

FLAG ALU SIGN
cod. 101361 ~ 15/10 - cm. 15x10
cod. 101362 ~ 15/15 - cm. 15x15
cod. 101363 ~ 15/20 - cm. 15x20
cod. 101364 ~ 15/30 - cm. 15x30
cod. 101365 ~ 15/40 - cm. 15x40



TAPPI TERMINALI END CAP - INTERNI
cod. 101372 - Black - 1 pcs.
cod. 101374 - Grey - 1 pcs.



TAPPI TERMINALI END CAP - ESTERNI
cod. 101373 - Black - 1 pcs.
cod. 101375 - Grey - 1 pcs.



SUSPENSION ALUSIGN | SEGNALETICA A SOSPENSIONE

- Profilo cm 15
- Alluminio anodizzato
- Protezione PVC trasparente
- 2 cavi in acciaio da 100 cm e 2 tiranti Magic inclusi
- Tappi terminali in plastica Neri (Grigi su richiesta)
- Profile cm 15
- Anodized Aluminium
- Clear PVC cover
- 2 Steel cable and 2 top wall fitting "Magic" included.
- Plastic End Cap Black or Grey

SUSPENSION ALU SIGN
cod. 101381 ~ 15/50 - cm. 15x50
cod. 101382 ~ 15/60 - cm. 15x60
cod. 101383 ~ 15/70 - cm. 15x70
cod. 101384 ~ 15/90 - cm. 15x90
cod. 101385 ~ 15/100 - cm. 15x100
cod. 101386 ~ 15/120 - cm. 15x120

TAPPI TERMINALI END CAP - ESTERNI
cod. 101373 - Black - 1 pcs.
cod. 101375 - Grey - 1 pcs.



CABLE Cavo in acciaio con guaina trasparente. Ø 1,5 mm.
Steel cable. Ø 1,5 mm.

cod. 104170 ~ 1 mt.
cod. 104172 ~ 100 mt.

MAGIC Tirante fisso superiore MAGIC
Top wall fitting MAGIC

cod. 104003 ~ MAGIC

WOOD DISPLAYS



Soluzioni in legno a lavagna scrivibile.



Wood solutions with writable blackboards.



WOOD A-BOARD | CAVALLETTO LAVAGNA

Cavalletto bifacciale a lavagna scrivibile. Realizzato in legno.

- Realizzato in legno
- Fondo scrivibile
- Profili legno 35x18 mm
- Imballato singolarmente
- Fornito già montato

- Made in wood
- Write A-Board
- Wood profile 35x18 mm
- Single packed
- No tool assembly

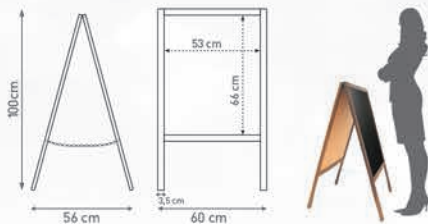

Wood A-Board	Chalkboard	External HxLxD	Weight	CTN	PLT
cod. 103601	cm 53x66	cm 100x60x56	Kg 3,35 ca.	1	35



TABLE TOP | LAVAGNA DA BANCO

Lavagna scrivibile da banco bifacciale.

- Realizzato in legno
- Fondo scrivibile
- Disponibile 22x23H. e 27x32H.
- Imballato singolarmente

IL PRODOTTO PUÒ ESSERE FORNITO STAMPATO. STAMPA DIRETTA A COLORI - ALTA DEFINIZIONE.

- Made in wood
- Write A-Board
- Available 22x23H. / 27x32H.
- Single packed

cod. 103621 ~ TABLE TOP A5 - 15x21 cm.

cod. 103622 ~ TABLE TOP A4 - 21x30 cm.

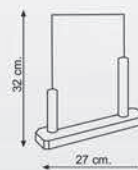
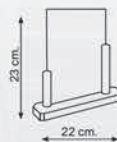

FLUOMARKER

Pennarelli Fluorescent
Fluorescent markers

- cod. 920012 ~ GREEN
- cod. 920013 ~ YELLOW
- cod. 920014 ~ BLUJETTE
- cod. 920015 ~ RED
- cod. 920016 ~ PINK
- cod. 920017 ~ WHITE
- cod. 920018 ~ ORANGE



COLOURED CHALK



cod. 920019 ~ 10 PCS



WOODEN FRAME BARS | BARRE PER TELAIO IN LEGNO

Barre in legno naturale per realizzazione telai. Per stampe su canvas o banner in PVC. Nelle lunghezze da 20 a 70 cm.

- Legno naturale
- Montaggio ad incastro
- Spessore barre 3,4x2 cm
- Barre vendute singolarmente
- Natural wood bar
- Interlocking assembly
- Thickness bars 3.5 x 2 cm.
- Available lengths from 20 to 70 cm.

cod. 103623 ~ WOODEN FRAME BAR - 20 cm.
cod. 103624 ~ WOODEN FRAME BAR - 30 cm.
cod. 103625 ~ WOODEN FRAME BAR - 40 cm.
cod. 103626 ~ WOODEN FRAME BAR - 50 cm.
cod. 103627 ~ WOODEN FRAME BAR - 60 cm.
cod. 103628 ~ WOODEN FRAME BAR - 70 cm.

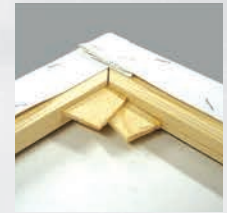

HANG | LAVAGNA

Lavagna da parete realizzata in legno. Fondo scrivibile

- Fondo scrivibile
- Dimensione 47x60 cm
- Uso Orizzontale e Verticale

Chalk boards. Made of wood

- Writable
- Sizes 47x60 cm
- Use Portrait and Landscape

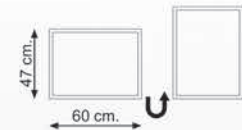
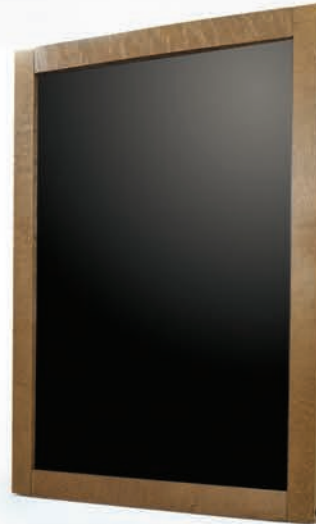

cod. 103611 ~ HANG 47x60 cm.



WOODEN EASEL | CAVALLETTO IN LEGNO

Cavalletto in legno naturale.

- Altezza totale 178 cm.

Easel made of wood.

- Total height 178 cm.

cod. 103612 ~ WOODEN EASEL

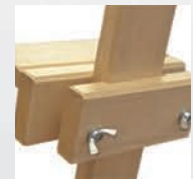
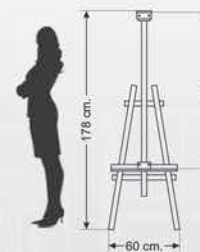

FLUOMARKER

Pennarelli Fluorescenti
Fluorescent markers

cod. 920012 ~ GREEN	
cod. 920013 ~ YELLOW	
cod. 920014 ~ BLUETTE	
cod. 920015 ~ RED	
cod. 920016 ~ PINK	
cod. 920017 ~ WHITE	
cod. 920018 ~ ORANGE	

COLOURED CHALK



cod. 920019 ~ 10 PCS

BROCHURE HOLDERS



Portadepliant e portacataloghi da pavimento. Disponibili in varie soluzioni.



Freestanding brochure holders for
depliant. Available in many solutions.



new FLOOR | PORTADEPLIANT SU PALO

Portadepliant da pavimento costituito da montante in alluminio, base in ferro e portadepliant in acrilico trasparente.

- Disponibile in varie configurazioni.
- Altezza Palo 120 cm
- Diametro Base 30 cm

Floor brochure holder. Iron base, aluminium pole with acrylic brochure holder.

- Available on different configurations.
- Height Pole 120 cm
- Diameter Base 30 cm

cod. 104400 ~ POLE+BASE FLOOR (BASE + PALO)

- ① cod. 104403 ~ FLOOR BHDL-2T - 2*1/3 A4 PORTRAIT
- cod. 104406 ~ FLOOR BHDL-4T - 4*1/3 A4 PORTRAIT
- cod. 104401 ~ FLOOR BHA5-TL - A5 LANDSCAPE
- ② cod. 104407 ~ FLOOR BHA5-4T - 4*A5 PORTRAIT
- cod. 104405 ~ FLOOR BHA4-3T - 3*A4 PORTRAIT
- ③ cod. 104408 ~ FLOOR BHA4-4T - 4*A4 PORTRAIT

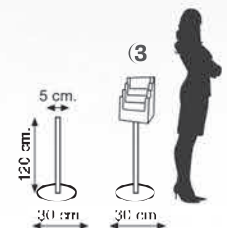

new STORE | PORTADEPLIANT SU PALO

Portadepliant da pavimento costituito da montante in alluminio, base in ferro e portadepliant in acrilico trasparente.

- Portadepliant trasparente A4
- Altezza Palo 120 cm
- Diametro Base 30 cm

Floor brochure holder. Iron base, aluminium pole with acrylic brochure holder A4.

- Brochure Holder Clear - A4
- Height Pole 120 cm
- Diameter Base 30 cm

cod. 104450 ~ NEW STORE

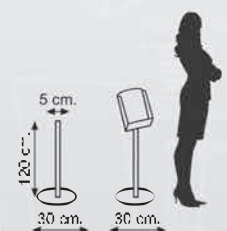



FOLDABLE PORTADEPLIANT PIEGHEVOLE

La forma a zig zag fanno del foldable un portacataloghi comodo per il trasporto ed unico nel design. Altezza cm 153 - 6 ripiani formato A4 in metacrilato trasparente, struttura in alluminio, cromato lucido. La valigetta tipo 24 ore in alluminio con protezioni antiurto fa del foldable il portacataloghi da pavimento più longevo della sua categoria.

- Altezza 153
- 6 ripiani trasparenti A4
- Valigetta in alluminio con protezioni inclusa.

Fast and easy to use 6 pocket literature rack. The brochure trays perfectly accommodate A4 brochures.

- Height 153
- 6 Shelves A4 - clear
- Aluminium carry case included

cod. 104421 ~ FOLDABLE

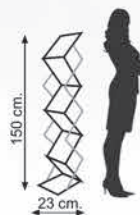

FAST PORTADEPLIANT PIEGHEVOLE

Portadepliant da pavimento nato per chi ha esigenze di muoversi continuamente senza avere grossi ingombri. Leggero ma stabile. Struttura in metallo e tasche in metacrilato trasparente. 4 tasche formato A4, profondità 3,5 cm, con spigoli arrotondati. Struttura a "scala" ripiegabile, base in ferro cromato con maniglia per il trasporto.

- Altezza 157 cm
- 4 tasche trasparenti A4 - profondità 3,5 cm
- Sacca per il trasporto inclusa

Fast and easy to use 4 pocket literature rack. The brochure trays perfectly accommodate A4 brochures.

- Height 157 cm
- 4 pocket clear A4 - Depth 3,5 cm
- Carrying case included

cod. 104449 ~ FAST

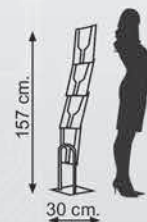



new READING | LEGGIO

Leggio da pavimento realizzato con montante in alluminio, base in ferro pesante. Reading monta una cornice a scatto con sistema clik-clak e protezione in pvc con angolo tondo in alluminio cromato. Utilizzabile sia in orizzontale che in verticale. Disponibile nel formato A4 e A3.

- Profilo cornice a scatto 25 mm
- Angolo Tondo
- Uso Orizzontale e Verticale
- Altezza Palo 120 cm
- Diametro Base 30 cm

Reading available in A3 and A4 sizes both in landscape & portrait positions. Available with snap frame A4 or A3.

- Snap frame profile 25 mm.
- Round Corner
- Use Portrait / Landscape
- Height Pole 120 cm
- Diameter Base 30 cm



cod. 104423 ~ READING A4

cod. 104424 ~ READING A3



WMBH EASY

Portadepliant in Acrilico Trasparente. A5-A4-1/3A4
Brochure holder - Clear.
A5-A4-1/3A4

cod. 102491 - DL

cod. 102492 - A5

cod. 102493 - A4



* È POSSIBILE ACCESSORIARE IL READING CON I PORTADEPLIANTI TRASPARENTI

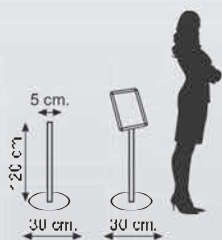



EASY POLE S230

Palo in alluminio con base in ferro. Applicate n° 1 cornice a scatto A3 angolo tondo orizzontale e n° 3 portadepliant A4 verticale.

- 1 Cornice a scatto A3 profilo 25 mm
 - 3 Portadepliant A4 trasparenti
 - Altezza 200 cm
 - Diametro Base 30 cm
- 1 snap frame A3 round corner landscape
 - 3 brochure holder A4 portrait
 - Height 200 cm
 - Diameter base 30 cm

- 1x 102702 ~ EASY STAND BASE
- 1x 102703 ~ EASY STAND PROFILE
- 1x 102704 ~ EASY END CAP
- 1x 102682 ~ SNAP FRAME A3 - 25 mm.
- 3x 102493 ~ PORTADEPLIANT A4

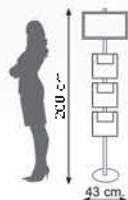

cod. 102911 ~ EASY POLE S230



ROUND CORNER



WMBHA4 EASY

Portadepliant in Acrilico Trasparente. A4 Brochure holder . Clear. A4

cod. 102493



BROCHURE TABLE

Banchetto multifunzionale con 3 porta depliant A3 e piano d'appoggio. Struttura pieghevole in acciaio verniciato a polvere, solido ed elegante. Apertura semplice e veloce.

- 3 ripiani portadepliant cm 43,5x35,5x2,2
- Piano di appoggio cm 51,3x37 ca.
- Altezza 101,5 ca. (aperto)
- Borsa imbottita per il trasporto inclusa

Multi-functional A3 size brochure holder display with a table top. Feature a fold-up design in powder coated steel, solid and stylish. Perfect tool for travelling salesmen or trade show exhibitors

- 3 x A3 brochure holder cm 43,5x35,5x2,2
- Table top cm
- Height 101,5 ab. (open)
- Padded bag included

cod. 104432 ~ BROCHURE TABLE



SIGN STANDOFF



Distanziali in tanti materiali, forme e colori. Targhe e tasche per ogni esigenza.



Standoffs in many materials, shapes and colors. Plates and pockets for every need.



ALUMINIUM STANDOFFS | DISTANZIALI ALLUMINIO

1313 - 1319 - 1925

Distanziali in alluminio, consentono il montaggio di pannelli e targhe di diversi formati e spessori. Non necessitano di materiali per il montaggio, non servono né viti né chiavi a brugola. Basta avvitare la testa sul distanziale e la targa è posizionata.

- Realizzato in: Alluminio
- Chiusura: Avvitamento
- Colori Disponibili: 6
- Foro: Ø 10 mm.
- Max. Peso Supportato: 15 kg.

Aluminum Standoffs. Ideal for indoor or outdoor mounting of signs, glass panels, photographic frames, artwork, etc.

- Made of: Aluminium
- Locking: Hand-Screw
- Colours Available: 6
- Hole: ø 10 mm.
- Max. Weight Supported: 15 kg.



ALU SMALL 1313

- | | |
|---|----------------------|
| ① | cod. 100401 ~ SILVER |
| ② | cod. 100402 ~ RED |
| ③ | cod. 100403 ~ BLUE |
| ④ | cod. 100404 ~ GOLD |
| ⑤ | cod. 100405 ~ BLACK |
| ⑥ | cod. 100406 ~ CHROME |

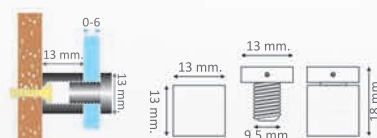

- **BOX:** 60 pz. [18,5x10x6 cm - 0,600 Kg]
- **CTN:** 360 pz. [32x20,5x15 cm - 3,750 Kg]

ALU MEDI 1319

- | | |
|---|----------------------|
| ① | cod. 100411 ~ SILVER |
| ② | cod. 100412 ~ RED |
| ③ | cod. 100413 ~ BLUE |
| ④ | cod. 100414 ~ GOLD |
| ⑤ | cod. 100415 ~ BLACK |
| ⑥ | cod. 100416 ~ CHROME |

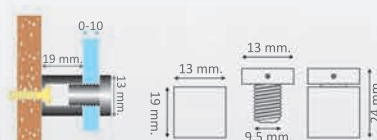

- **BOX:** 60 pz. [18,5x10x6 cm - 0,750 Kg]
- **CTN:** 360 pz. [32x20,5x15 cm - 4,050 Kg]

ALU LARGE 1925

- | | |
|---|----------------------|
| ① | cod. 100421 ~ SILVER |
| ② | cod. 100422 ~ RED |
| ③ | cod. 100423 ~ BLUE |
| ④ | cod. 100424 ~ GOLD |
| ⑤ | cod. 100425 ~ BLACK |
| ⑥ | cod. 100426 ~ CHROME |

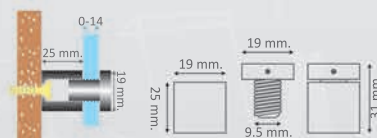

- **BOX:** 40 pz. [18,5x10x6 cm - 1,080 Kg]
- **CTN:** 240 pz. [32x20,5x15 cm - 6,300 Kg]



Design by Ark Display

ALU DOUBLE DISTANZIALI DOPPI

Distanziali Doppi. Realizzati in alluminio con finitura opaca. Consentono il montaggio di 2 pannelli o targhe contemporaneamente. Per pannelli e targhe di diversi formati e spessori. Oltre ai distanziali disponibili in 2 dimensioni è possibile scegliere la lunghezza del grano (parte filettata) in base allo spessore delle targhe da montare. I distanziali doppi vengono forniti con 2 grani da 9,5 mm. per targhe max. 3 mm.

- Realizzato in: Alluminio
- Chiusura: Avvitamento
- Colore: Silver
- Grani Opzionali per targhe spesse fino a 10 mm.
- Foro: \varnothing 9 mm.
- Max. Peso Supportato: 15 kg.

Double Aluminum Standoffs. Ideal for indoor or outdoor mounting of signs, architectural plaques, glass panels, photographic, frames, artwork. For mounting two plates at same time.

- Made of: Aluminium
- Locking: Hand-Screw
- Colour: Silver
- Optional grain for sign up to 10 mm. thick
- Hole: \varnothing 9 mm.
- Max. Weight Supported: 15 kg.



ALU DOUBLE 1515
cod. 100507

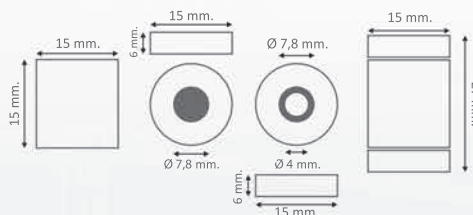
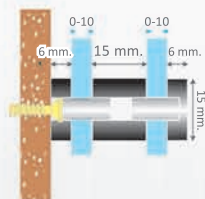

BOX: 60 pz.
[18,5x10x6 cm - 0,880 Kg]
CTN: 360 pz.
[32x20,5x15 cm - 5,450 Kg]



ALU DOUBLE 1525
cod. 100508

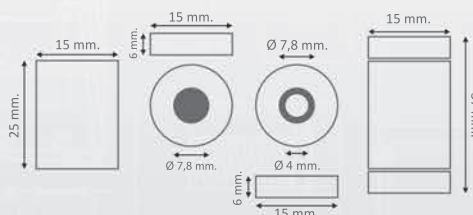
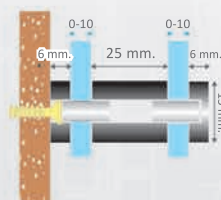

BOX: 60 pz.
[18,5x10x6 cm - 1,200 Kg]
CTN: 360 pz.
[32x20,5x15 cm - 7,350 Kg]

DOUBLE GRAIN 13
cod. 100509



PER TARGHE MAX. 5 mm. DI SPESSORE

DOUBLE GRAIN 19
cod. 100510



PER TARGHE MAX. 10 mm. DI SPESSORE



Design by Ark Display

ALU MAGNUM DISTANZIALI MAGNUM IN ALLUMINIO



Distanziali magnum realizzati in alluminio. Non necessitano di materiali per il montaggio, non servono nè viti nè chiavi a brugola. Basta avvitare la testa sul distanziale e la targa è posizionata. Il distanziale è disponibile in 4 formati differenti.

- Realizzato in: Alluminio
- Chiusura: Avvitamento
- Colore: Silver
- Max. Spessore Targa: 28 mm.
- Max. Distanza dalla Parete: 60 mm.
- Max. Peso Supportato: 15 kg.
- Formati Disponibili: 4

Aluminum Magnum Standoffs. Ideal for indoor or outdoor mounting of signs, architectural plaques, glass panels, photographic, frames, artwork, etc. 4 sizes available. Silver colour.

- Made of: Aluminium
- Locking: Hand-Screw
- Colour: Silver
- Max. Sign thickness: 28 mm.
- Max. Distance from Wall: 60 mm.
- Max. Weight Supported: 15 kg.
- Available sizes: 4

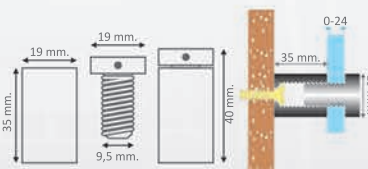

ALU MAGNUM 1935 cod. 100417

BOX: 40 pz.
 [18,5x10x6 cm - 1,330 Kg]
CTN: 240 pz.
 [32x20,5x15 cm - 8,000 Kg]

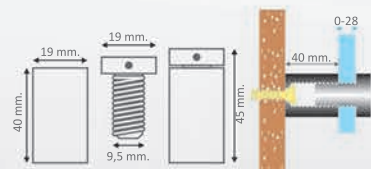

ALU MAGNUM 1940 cod. 100418

BOX: 40 pz.
 [18,5x10x6 cm - 1,480 Kg]
CTN: 240 pz.
 [32x20,5x15 cm - 8,920 Kg]

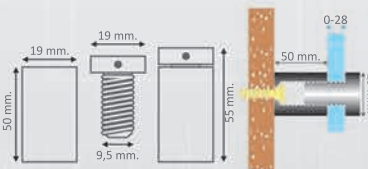

ALU MAGNUM 1950 cod. 100419

BOX: 40 pz.
 [18,5x10x6 cm - 1,680 Kg]
CTN: 240 pz.
 [32x20,5x15 cm - 10,120 Kg]

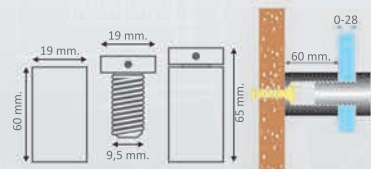

ALU MAGNUM 1960 cod. 100420

BOX: 24 pz.
 [18,5x10x6 cm - 1,180 Kg]
CTN: 144 pz.
 [32x20,5x15 cm - 7,100 Kg]



DISTANZIALI ACCIAIO | STEEL STANDOFFS

Distanziali realizzati in ACCIAIO "AISI 304". Consentono il montaggio di pannelli e targhe di diversi formati e spessori. Grazie alla chiusura laterale con vite a brugola il distanziale è adatto per montaggi di sicurezza.

- Realizzato in: Acciaio "AISI 304"
- Chiusura: Brugola (Chiavino Key 4 - non incluso)
- Colore: Acciaio
- Max. Peso Supportato: 15 kg.
- Formati Disponibili: 4

Steel "AISI 304" Standoffs. Ideal for indoor or outdoor mounting of signs, architectural plaques, glass panels, photographic frames, artwork, etc. - Use with Key 4 (not included).

- Made of: Steel "AISI 304"
- Locking: Allen Key (Allen Key 4 not included)
- Colour: Steel
- Max. Weight Supported: 15 kg.
- Available sizes: 4



ACCIAIO 1315
cod. 100482

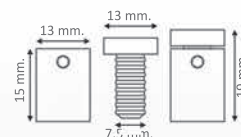
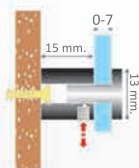

- **BOX:** 4 pz. [10x3,2x2 cm - 0,080 Kg]
- **CTN:** 400 pz. [32x20,5x15 cm - 8,320 Kg]

ACCIAIO 1515
cod. 100483

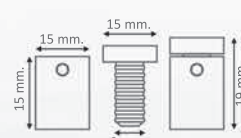
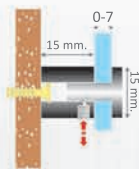

- **BOX:** 4 pz. [7x3,5x2 cm - 0,095 Kg]
- **CTN:** 400 pz. [32x20,5x15 cm - 9,900 Kg]

ACCIAIO 2020
cod. 100484

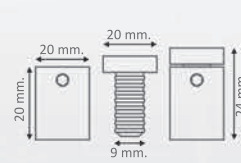
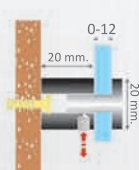

- **BOX:** 4 pz. [9x4,7x2 cm - 0,240 Kg]
- **CTN:** 200 pz. [22x20,5x15 cm - 11,900 Kg]

ACCIAIO LISCI0 1420
cod. 100682

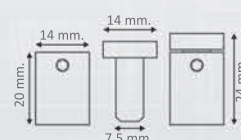
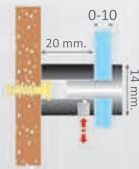

- **BOX:** 100 pz. [12x9x7 cm - 2,800 Kg]
- **CTN:** 240 pz. [25x28x15 cm - 33,700 Kg]

ALLEN KEY 4



Chiavino esagonale per distanziali
Allen key for standoffs

cod. 103502 - KEY 4



ARK BRASS DISTANZIALI IN OTTONE

Distanziali realizzati in OTTONE, consentono il montaggio di pannelli e targhe di diversi formati e spessori. Grazie alla chiusura laterale con vite a brugola il distanziale è adatto per montaggi di sicurezza.

- Realizzato in: Ottone
- Chiusura: Brugola (Chiavino Key 4 - non incluso)
- Max. Spessore Targa: 12 mm.
- Max. Peso Supportato: 15 kg.

Ark Brass. Standoffs made in brass. Can be mounted panels, and plates of different thickness. Lateral lock, mount the fastener to the wall.

- Made of: Brass
- Locking: Allen Key (Key 4 not included)
- Max. Sign thickness: 12 mm.
- Max. Weight Supported: 15 kg.



- ARK BRASS 1520**
- 1) cod. 100436 - SILVER
 - 2) cod. 100437 - CHROME
 - 3) cod. 100438 - GOLD

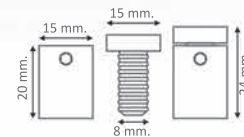
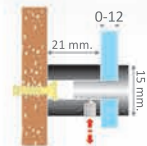

BOX: 40 pz.
[18,5x10x6 cm - 1,480 Kg]

CTN: 240 pz.
[32x20,5x15 cm - 8,900 Kg]

- ARK BRASS 1925**
- 1) cod. 100431 - SILVER
 - 2) cod. 100432 - CHROME

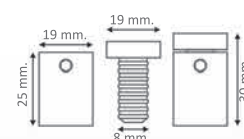
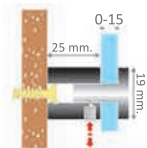

BOX: 40 pz.
[18,5x10x6 cm - 2,720 Kg]

CTN: 240 pz.
[32x20,5x15 cm - 16,350 Kg]

- ARK BRASS 2530**
- cod. 100441 - SILVER

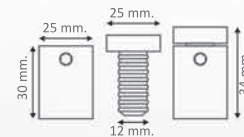
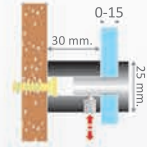

BOX: 24 pz.
[18,5x10x6 cm - 3,290 Kg]

CTN: 96 pz.
[32x20,5x15 cm - 13,250 Kg]

- ARK BRASS 2550**
- cod. 100451 - SILVER

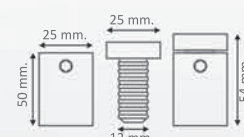
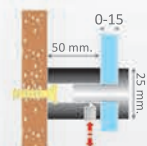

BOX: 12 pz.
[18,5x10x6 cm - 1,620 Kg]

CTN: 48 pz.
[22x20x15 cm - 6,580 Kg]

- ARK BRASS 3030**
- cod. 100461 - SILVER

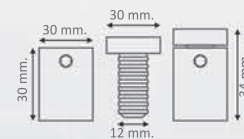
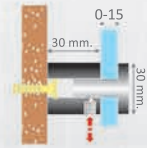

BOX: 12 pz.
[18,5x10x6 cm - 2,380 Kg]

CTN: 48 pz.
[22x20x15 cm - 9,600 Kg]

- ARK BRASS 4040**
- cod. 100471 - SILVER

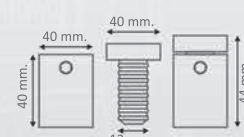
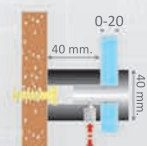

BOX: 4 pz.
[12x9x9 cm - 1,860 Kg]

CTN: 16 pz.
[22x20x15 cm - 7,500 Kg]

ALLEN KEY 4



Chiavino esagonale per distanziali
Allen key for standoffs

cod. 103502 ~ KEY 4



FIX SERIES | DISTANZIALI DORATI LUCIDI

Distanziali realizzati in acciaio con finitura oro lucido. Per pannelli e targhe di diversi formati e spessori.

- Realizzato in: Acciaio
- Chiusura: Avvitamento
- Colore: Oro Lucido
- Max. Peso Supportato: 15 kg.
- Formati Disponibili: 2

- Made of: Steel
- Locking: Hand-Screw
- Colour: Polish Gold
- Max. Weight Supported: 15 kg.
- Available sizes: 2

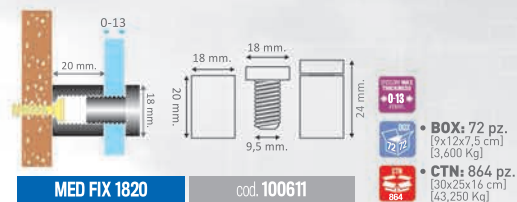

EMPTY SERIES | DISTANZIALI EMPTY

Distanziali realizzati con lamiera di acciaio (vuoto) e ferro. Per pannelli e targhe di diversi formati e spessori.

- Realizzato in: Acciaio vuoto e Ferro
- Chiusura: Avvitamento
- Colore: Acciaio satinato
- Max. Peso Supportato: 15 kg.
- Formati Disponibili: 3

- Made of: Empty steel and Iron
- Locking: Hand-Screw
- Colour: Satin steel
- Max. Weight Supported: 15 kg.
- Available sizes: 3

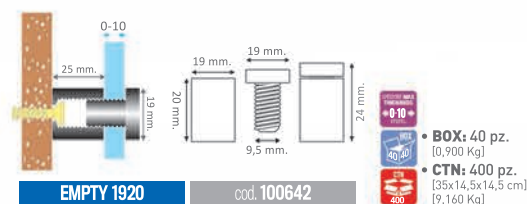
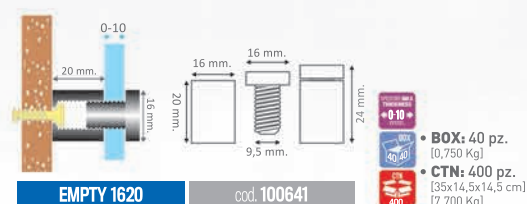

CLEAR STANDOFFS | DISTANZIALI TRASPARENTI

Distanziali realizzati in acrilico trasparente. Per pannelli e targhe di diversi formati e spessori.

- Realizzato in: Acrilico
- Chiusura: Avvitamento
- Colore: Trasparente
- Max. Peso Supportato: 15 kg.
- Formati Disponibili: 13x19 mm

- Made of: Acrylic
- Locking: Hand-Screw
- Colour: Clear
- Max. Weight Supported: 15 kg.
- Available sizes: 13x19 mm



 **klik
wall**



il nuovo distanziale a pressione...
MONTARE TARGHE E INSEGNE SENZA FORARE IL MATERIALE

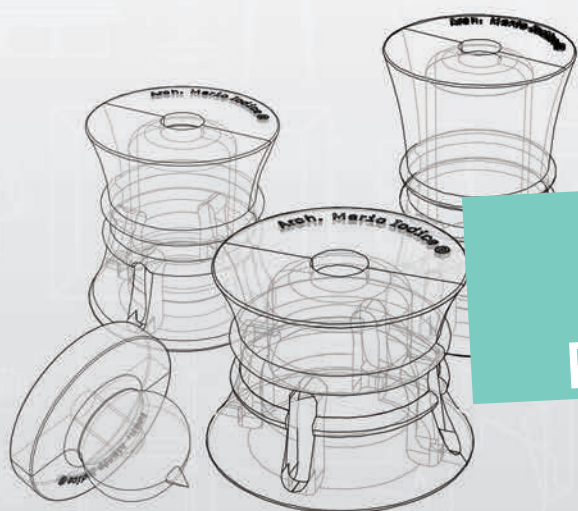

NUOVO PRODOTTO
NOSTRO DESIGN
PROGETTO ESCLUSIVO

un'esclusiva Ark Display



KLIKWALL | DISTANZIALE A PRESSIONE

PRODOTTO DEPOSITATO
Design Arch. Mario Iodice

Nuovo distanziale a pressione ideato da Ark Display. Realizzato in acrilico, completamente trasparente. Permette il montaggio di targhe, insegne, lettere sagomate in plex, quadri, pannelli, cartelli e per tutti i fissaggi a parete. Invisibile, semplice da montare, veloce da sostituire.

- Realizzato in Acrilico
- Chiusura: a Pressione
- Colore: Trasparente
- Formati disponibili: 3

The new pressure standoff, designed by Ark Display. Made of acrylic, completely transparent. It allows the installation of plates, signs, shaped letters in plex, panels, signs and for all wall fixings. Invisible, easy to assemble, quick to replace.

- Made of Acrylic
- Closing: by pressure
- Color: Transparent
- Available formats: 3

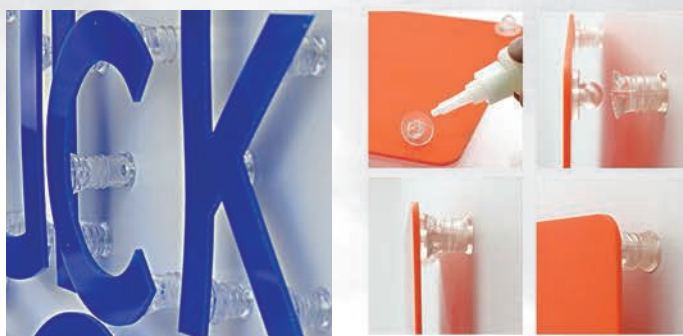

MONTARE TARGHE E INSEGNE
SENZA FORARE IL MATERIALE

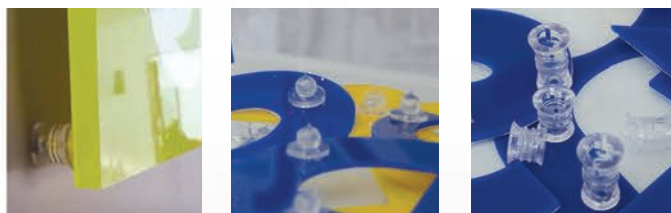

KLIKWALL 2018
cod. 100498

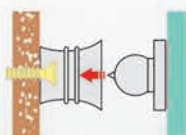

15 mm
17 mm
20 mm
18 mm



• **BOX:** 50 pz.
[18,5x10x6 cm - 0,300 Kg]

KLIKWALL 2023
cod. 100499

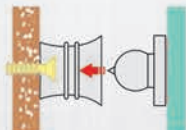

20 mm
17 mm
20 mm
23 mm



• **BOX:** 50 pz.
[18,5x10x6 cm - 0,300 Kg]

KLIKWALL 2033
cod. 100500

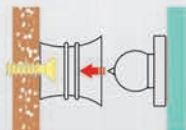

30 mm
17 mm
20 mm
33 mm



• **BOX:** 50 pz.
[18,5x10x6 cm - 0,300 Kg]

KLIK GLUE

Colla viscosa per Klickwall e lastre acriliche. Con beccuccio di precisione. Contenuto 50 ml.
Acrylic glue for Klickwall
Cont. 50 ml
cod. 706180 ~ 50 ml



FORNIAMO LETTERE E LOGHI IN PLEXI O FOREX. TANTI COLORI E SPESSORI DISPONIBILI.
* SU RICHIESTA.





DOT | COPRIVITE

Copriviti avvitabili. Consentono il montaggio di pannelli di diversi formati e spessori.

- Realizzati in: Ottone e Alluminio
- Chiusura: Avvitamento
- Colore: Cromo - Oro - Argento
- Spessore: 5 mm.
- Formati Disponibili: 3
- Made of: Brass and Aluminium
- Locking: Hand-Screw
- Colour: Chrome - Gold - Silver
- Thickness: 5 mm.
- Available sizes: 3

* Foro 6 mm - Testa vite max. 10 mm

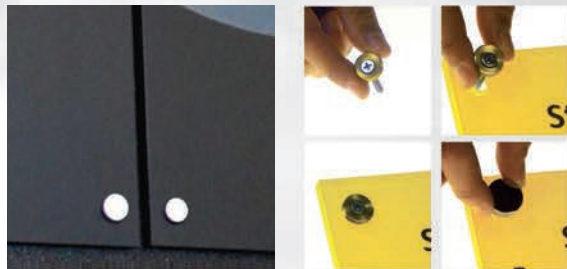

DOT BRASS
cod. 100491 - 15 mm - Chrome
cod. 100492 - 19 mm - Chrome
cod. 100493 - 25 mm - Chrome
cod. 100495 - 15 mm - Gold



- Ottone / Brass
- BOX: 100 pz.
- CTN: 600 pz.

DOT ALU
cod. 100488 - 15 mm - Silver
cod. 100489 - 19 mm - Silver



- Alluminio / Aluminium
- BOX: 100 pz.
- CTN: 600 pz.



ALU | PROFILI RAIL | PORTATARGHE

Binario in alluminio per il montaggio di più targhe. Eviterai di farli tanti fori nel muro. Sostituzione delle targhe semplice e veloce. Disponibile in varie lunghezze. Si consiglia l'utilizzo dei coprivite DOT per il montaggio delle targhe.

- Binario portatarghe
- Alluminio
- Completo di tappi finali grigi

Aluminum rail for the mounting of plates. Thanks to binary headlights will avoid many holes in the wall. Available in different lengths including end caps. Recommended use with screw cover DOT

- Aluminium
- End caps included

cod. 101111 ~ ALU RAIL 50 cm. - 1 pcs
cod. 101112 ~ ALU RAIL 100 cm. - 1 pcs
cod. 101113 ~ ALU RAIL 150 cm. - 1 pcs
cod. 101114 ~ ALU RAIL 200 cm. - 1 pcs
cod. 101115 ~ ALU RAIL 250 cm. - 1 pcs

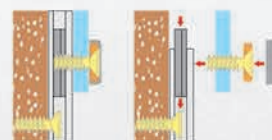

ATTENZIONE

OGNI PROFILO È COMPLETO DI:

- 2 FORI
- 2 TAPPI FINALI GRIGI

Every profile is complete with 2 holes and 2 caps gray

RAIL PLATE

Piastra e vite per Alu Rail
Plate and screw for Alu Rail

cod. 101119



Design by Ark Display

ENSIGN | DISTANZIALE A BANDIERA

Fissaggio a parete/soffitto per targhe a bandiera o sospeso (soffitto).

- Realizzato in: Alluminio
- Chiusura: Brugola (Chiavino Key 4 - non incluso)
- Colore: Silver
- Max. Spessore Targa: 4,5 mm.

- Made of: Aluminium
- Locking: Allen Key (Allen Key 4 not included)
- Colour: Silver
- Max. Sign thickness: 4,5 mm.

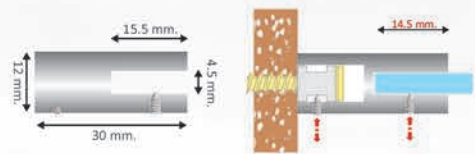
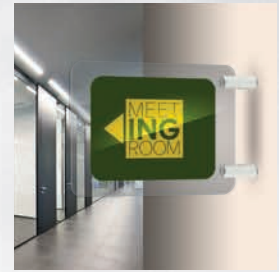

cod. 100502 ~ ENSIGN



- **BOX:** 60 pz. [18,5x10x6 cm - 0,570 Kg]
- **CTN:** 360 pz. [32x20,5x15 cm - 3,450 Kg]



Design by Ark Display

SIDE | DISTANZIALE LATERALE

Distanziale in alluminio laterale a parete. Utilizzo senza fori sulle targhe.

- Realizzato in: Alluminio
- Chiusura: Brugola (Chiavino Key 4 - non incluso)
- Colore: Silver
- Formati Disponibili: 2

- Made of: Aluminium
- Locking: Allen Key (Allen Key 4 not included)
- Colour: Silver
- Available sizes: 2

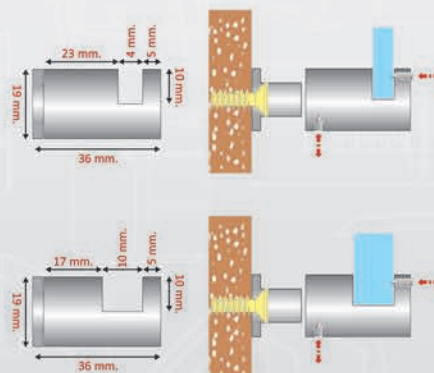

① cod. 100503 ~ SIDE 4 mm.



- **BOX:** 40 pz. [18,5x10x6 cm - 1,000 Kg]
- **CTN:** 240 pz. [32x20,5x15 cm - 6,100 Kg]

② cod. 100504 ~ SIDE 10 mm.



- **BOX:** 40 pz. [18,5x10x6 cm - 0,960 Kg]
- **CTN:** 240 pz. [32x20,5x15 cm - 5,820 Kg]



Design by Ark Display

ALU4WAYS | DISTANZIALI 4 VIE

Si posiziona nell'angolo della targha. Grazie all'anima centrale a croce ogni distanziale è in grado di supportare fino a 4 targhe, consentendo così di formare composizioni di vario genere.

- Realizzato in: Alluminio
- Chiusura: Brugola (Chiavino Key 4 - non incluso)
- Colore: Silver
- Made of: Aluminium
- Locking: Allen Key (Allen Key 4 not included)
- Colour: Silver



- BOX: 24 pz. [18,5x10x6 cm - 0,940 Kg]
- CTN: 144 pz. [32x20,5x15 cm - 5,700 Kg]



cod. 100506 ~ ALU 4 WAYS

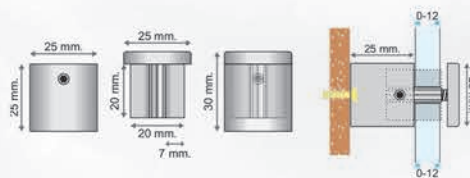

TARGHE NO HOLE

- cod. 101039 ~ 30x20 - 8 mm
- cod. 101040 ~ 40x30 - 8 mm



ROLLING | DISTANZIALE A ROTAZIONE

Realizzato in acciaio. Utilizzo sia fisso che a rotazione. Adatto come distanziale a bandiera, ideale per creare espositori a libro.

- Realizzato in: Acciaio
- Chiusura: Brugola (Chiavino non incluso)
- Colore: Acciaio
- Max. Spessore Targha: 4 mm.
- Montaggio su pannello



- BOX: 60 pz. [18,5x10x6 cm - 2,680 Kg]
- CTN: 240 pz. [22x20x15 cm - 10,800 Kg]

Made of steel. It can be used to flag or rotation system. Max. thickness supported 4mm. Require allen keys NOT included.

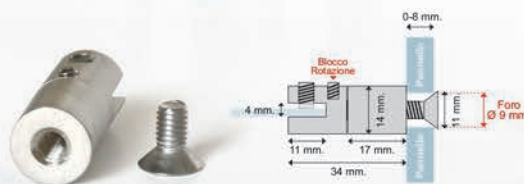

BULLET | SOSTEGNO PER TARGHE

Sostegno per targhe. Realizzato in alluminio. Adatto a diversi spessori. Per realizzare targhe autoportanti.

- Lunghezza: 77 mm - Diametro: 7 mm;
- Diametro vite: 5mm - Diametro foro: 6 mm;
- Spessore max ospitabile: 8 mm

Support system for plates. Made of aluminum. Suitable for different thicknesses.

- Length: 77 mm - Diameter: 7 mm;
- Screw diameter: 5mm - Hole diameter: 6 mm;
- Hospitable max thickness: 8 mm

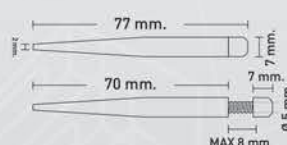
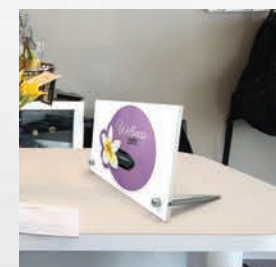

cod. 100505 ~ BULLET



PLATE | TARGHE IN ACRILICO TRASPARENTE



Targhe in acrilico colato trasparente. Ideali come targhe, segnaletica direzionale, indicatori di direzione ecc. Complete di fori per l'inserimento dei distanziali. Disponibili con angoli tondi e vivi, in diversi spessori e forme. Possono essere personalizzate con adesivo prespaziato, adesivo stampato o stampa diretta. Utilizzo orizzontale e verticale.

Transparent acrylic plates . Ideal for making plates, directional signs, turn signals, etc. Complete with holes. Can be used both landscape or portrait.

- Taglio laser
- Angolo Vivo e Angolo Tondo
- Varie forme e spessori

- Laser cutting
- Mitred and round corners
- Various thicknesses and shapes available

MITRED PLATE | TARGHE CON ANGOLO VIVO



M8 PLATE ~ SPESSORE 8 mm	
cod. 101001 ~ M8 PLATE 13x8 cm. - 2 FORI/HOLES *	
cod. 101002 ~ M8 PLATE 20x10 cm. - 2 FORI/HOLES *	
cod. 101011 ~ M8 PLATE 20x20 cm. - 4 FORI/HOLES *	
cod. 101003 ~ M8 PLATE 25x18 cm. - 4 FORI/HOLES *	
cod. 101005 ~ M8 PLATE 30x20 cm. - 4 FORI/HOLES *	
cod. 101006 ~ M8 PLATE 30x30 cm. - 4 FORI/HOLES *	
cod. 101007 ~ M8 PLATE 30x40 cm. - 4 FORI/HOLES *	
cod. 101008 ~ M8 PLATE 35x50 cm. - 4 FORI/HOLES *	
cod. 101009 ~ M8 PLATE 40x60 cm. - 4 FORI/HOLES *	
cod. 101010 ~ M8 PLATE 50x70 cm. - 4 FORI/HOLES *	

M5 PLATE ~ SPESSORE 5 mm	
cod. 101042 ~ M5 PLATE 13x8 cm. - 2 FORI/HOLES *	
cod. 101043 ~ M5 PLATE 20x10 cm. - 2 FORI/HOLES *	
cod. 101044 ~ M5 PLATE 20x20 cm. - 4 FORI/HOLES *	
cod. 101045 ~ M5 PLATE 25x18 cm. - 4 FORI/HOLES *	
cod. 101046 ~ M5 PLATE 30x20 cm. - 4 FORI/HOLES *	
cod. 101047 ~ M5 PLATE 30x30 cm. - 4 FORI/HOLES *	
cod. 101048 ~ M5 PLATE 30x40 cm. - 4 FORI/HOLES *	
cod. 101049 ~ M5 PLATE 35x50 cm. - 4 FORI/HOLES *	
cod. 101050 ~ M5 PLATE 40x60 cm. - 4 FORI/HOLES *	
cod. 101051 ~ M5 PLATE 50x70 cm. - 4 FORI/HOLES *	

M3 PLATE ~ SPESSORE 3 mm	
cod. 101055 ~ M3 PLATE 13x8 cm. - 2 FORI/HOLES *	
cod. 101056 ~ M3 PLATE 20x10 cm. - 2 FORI/HOLES *	
cod. 101057 ~ M3 PLATE 20x20 cm. - 4 FORI/HOLES *	
cod. 101058 ~ M3 PLATE 25x18 cm. - 4 FORI/HOLES *	
cod. 101059 ~ M3 PLATE 30x20 cm. - 4 FORI/HOLES *	
cod. 101060 ~ M3 PLATE 30x30 cm. - 4 FORI/HOLES *	
cod. 101061 ~ M3 PLATE 30x40 cm. - 4 FORI/HOLES *	
cod. 101062 ~ M3 PLATE 35x50 cm. - 4 FORI/HOLES *	
cod. 101063 ~ M3 PLATE 40x60 cm. - 4 FORI/HOLES *	
cod. 101064 ~ M3 PLATE 50x70 cm. - 4 FORI/HOLES *	

ROUND PLATE | TARGHE CON ANGOLO TONDO



R5 PLATE ~ SPESSORE 5 mm	
cod. 101069	~ R5 PLATE 13x8 cm. - 2 FORI/HOLES *
cod. 101070	~ R5 PLATE 20x10 cm. - 2 FORI/HOLES *
cod. 101071	~ R5 PLATE 25x18 cm. - 4 FORI/HOLES *
cod. 101072	~ R5 PLATE 30x20 cm. - 4 FORI/HOLES *
cod. 101073	~ R5 PLATE 30x40 cm. - 4 FORI/HOLES *
cod. 101074	~ R5 PLATE 35x50 cm. - 4 FORI/HOLES *
cod. 101075	~ R5 PLATE 40x60 cm. - 4 FORI/HOLES *
cod. 101076	~ R5 PLATE 50x70 cm. - 4 FORI/HOLES *

R4 PLATE ~ SPESSORE 4 mm	
cod. 101021	~ R4 PLATE 30x20 cm. - 4 FORI/HOLES *
cod. 101022	~ R4 PLATE 30x40 cm. - 4 FORI/HOLES *

R3 PLATE ~ SPESSORE 3 mm	
cod. 101079	~ R3 PLATE 13x8 cm. - 2 FORI/HOLES *
cod. 101080	~ R3 PLATE 20x10 cm. - 2 FORI/HOLES *
cod. 101081	~ R3 PLATE 25x18 cm. - 4 FORI/HOLES *
cod. 101082	~ R3 PLATE 30x20 cm. - 4 FORI/HOLES *
cod. 101083	~ R3 PLATE 30x40 cm. - 4 FORI/HOLES *
cod. 101084	~ R3 PLATE 35x50 cm. - 4 FORI/HOLES *
cod. 101085	~ R3 PLATE 40x60 cm. - 4 FORI/HOLES *
cod. 101086	~ R3 PLATE 50x70 cm. - 4 FORI/HOLES *

ELIPSE PLATE | TARGHE A FORMA ELLITTICA

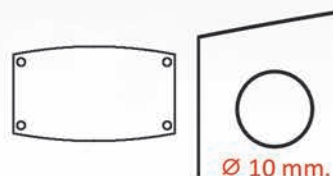

E8 PLATE ~ SPESSORE 8 mm	
cod. 101089	~ E8 PLATE 21x12 cm. - 4 FORI/HOLES *
cod. 101090	~ E8 PLATE 30x17,2 cm. - 4 FORI/HOLES *
cod. 101091	~ E8 PLATE 40x23 cm. - 4 FORI/HOLES *
cod. 101092	~ E8 PLATE 50x29 cm. - 4 FORI/HOLES *
cod. 101093	~ E8 PLATE 60x35 cm. - 4 FORI/HOLES *

E5 PLATE ~ SPESSORE 5 mm	
cod. 101095	~ E5 PLATE 21x12 cm. - 4 FORI/HOLES *
cod. 101096	~ E5 PLATE 30x17,2 cm. - 4 FORI/HOLES *
cod. 101097	~ E5 PLATE 40x23 cm. - 4 FORI/HOLES *
cod. 101098	~ E5 PLATE 50x29 cm. - 4 FORI/HOLES *
cod. 101099	~ E5 PLATE 60x35 cm. - 4 FORI/HOLES *

E3 PLATE ~ SPESSORE 3 mm	
cod. 101102	~ E3 PLATE 21x12 cm. - 4 FORI/HOLES *
cod. 101103	~ E3 PLATE 30x17,2 cm. - 4 FORI/HOLES *
cod. 101104	~ E3 PLATE 40x23 cm. - 4 FORI/HOLES *

OVAL PLATE | TARGHE A FORMA OVALE

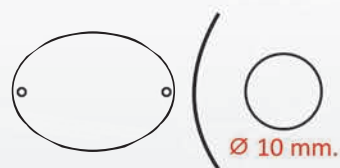

OVAL PLATE ~ SPESSORE 8 mm	
cod. 101015	~ OVAL PLATE 30x20 cm. - 2 FORI/HOLES *
cod. 101016	~ OVAL PLATE 30x40 cm. - 2 FORI/HOLES *

* Le targhe contrassegnate dall'asterisco possono essere fornite complete di
- Stampa Diretta UV -
 +Bianco + Trasparente Lucido

MAX. DIMENSIONE 42x30 cm.





POKET | TASCHE PORTAMESSAGGI

Tasche portamessaggi in acrilico colato trasparente. La particolare forma ad U consente un facile inserimento del messaggio. Utilizzare con il distanziale SIDE.

Poket it's a new product for show your message. Clear acrylic, U shape for easy use.

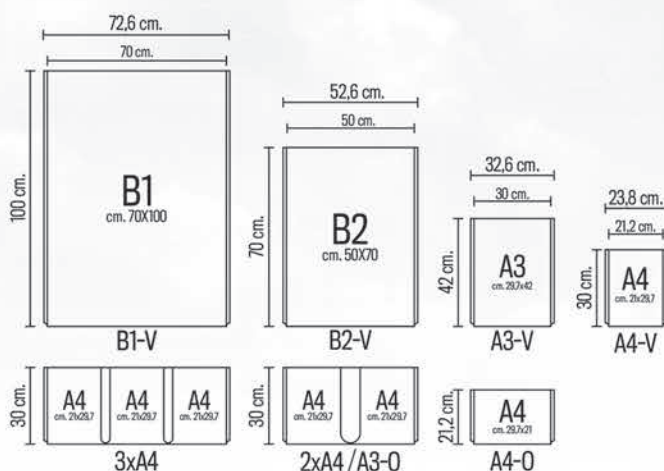

- cod. 104031 ~ POKET A4 - VERTICALE/PORTRAIT
- cod. 104032 ~ POKET A4 - ORIZZONTALE/LANDSCAPE
- cod. 104033 ~ POKET 2x A4 - VERTICALE/PORTRAIT
- cod. 104034 ~ POKET 3x A4 - VERTICALE/PORTRAIT
- cod. 104035 ~ POKET A3 - VERTICALE/PORTRAIT
- cod. 104036 ~ POKET B2 - cm. 50x70 - VERTICALE/PORTRAIT *
- cod. 104037 ~ POKET B1 - cm. 70x100 - VERTICALE/PORTRAIT *

*Costi di imballaggio / Packing cost

cod. 104040 ~ PACKING COST *

SIDE 4

Distanziale laterale a parete Standoff side wall.

cod. 100503 ~ SIDE 4 mm

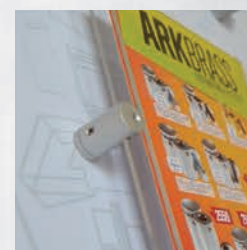

WALL POKET | TASCHE PORTAMESSAGGI DA PARETE

Tasche portamessaggi trasparenti. Dotate di fori sulle alette che consentono il montaggio con i distanziali.

- Fori per montaggio con distanziali
- Formato stampa 70x100 cm.
- Spessore materiale 4 mm.

Wall poket for show your message. Clear acrylic, can be mounting with standoffs. Poster size 70x100 cm. thickness 4 mm.

cod. 104051 ~ WALL POKET 70x100 *

*Costi di imballaggio / Packing cost

cod. 104040 ~ PACKING COST *





GRIP | PORTATARGA DA PARETE

Pratico ed elegante sistema portatarga in alluminio, privo di fori a vista e compatto nella struttura. Grip è un'ottima alternativa al distanziali.

- Formati: 8 e 12 cm.
- Finitura: Silver e Cromo.

System without punched holes. Compact aluminium profile silver or chrome finished, it's a excellent alternative to the standoff.

- Sizes: 8 and 12 cm.
- Silver or chrome finished

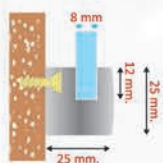

GRIP SILVER

cod. 104022 ~ GRIP 80 mm. - SILVER

cod. 104023 ~ GRIP 120 mm. - SILVER



GRIP CHROME

cod. 104025 ~ GRIP 80 mm. - CHROME

cod. 104026 ~ GRIP 120 mm. - CHROME

TARGHE NO HOLE



cod. 101039 ~ 30x20 - 8 mm

cod. 101040 ~ 40x30 - 8 mm

MINI MODULI LED



cod. 645303



È possibile montare i Mini Moduli LED per creare bellissime Targhe Luminose.



CONNECTOR | CONNETTORI PER PANNELLI

Connettori in alluminio per composizioni. Consentono di realizzare piccoli arredi o espositori sia fissi che mobili.

- Disponibili a 2, 3 e 4 vie
- Spessore max 6 mm.
- Dimensioni pannelli suggeriti: cm.: 60x30; 46,5x23; 40x40

Connectors to create and build small furniture or exhibitors both fixed and mobile. Available 2, 3 and 4 ways.

- Max thickness 6 mm.
- Acrylic size suggested: cm.: 60x30; 46.5x23; 40x40

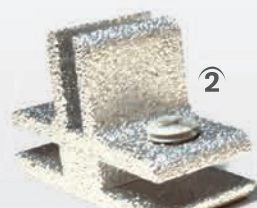
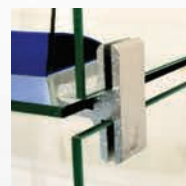

1 cod. 100521 ~ 2 WAY CONNECTOR

2 cod. 100522 ~ 3 WAY CONNECTOR

3 cod. 100523 ~ 4 WAY CONNECTOR

SIGN & TOTEM



Insegne, Totem e Cassonetti. Tante forme dimensioni e soluzioni.



Signs, Totem and Boxes. Many sizes shapes and solutions.



LIGHTED SIGN INSEGNA LUMINOSA BIFACCIALE

Insegne luminose bifacciali. Struttura in alluminio con agganci e pannelli opalino preformati. Personalizzabili con adesivo stampato o pvc prespaziato.

- Forme: Tonda, Rettangolare, Ovale
- Varie Dimensioni Disponibili.
- Spessore insegna 16 cm. ca.
- Luce Led
- Trasformatore 12 V incluso
- Pronta per il montaggio

Lighted sign double sided. Made of luminum with hooks and preformed opaline panels. Customizable with pvc adhesive.

- Shapes: Rounded, Squared, Oval
- Many Sizes Available.
- Thickness 16 cm. ab.
- Led Lights
- Transformer 12 V included

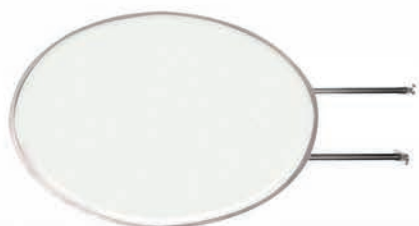

LIGHTED SIGN - OVALE
cod. 105105 ~ 50x35 cm
cod. 105106 ~ 80x55 cm
cod. 105107 ~ 120x70 cm



LIGHTED SIGN - TONDA
cod. 105109 ~ Ø 50 cm
cod. 105110 ~ Ø 70 cm
cod. 105111 ~ Ø 90 cm



LIGHTED SIGN - RETTANGOLARE O.
cod. 105114 ~ 70x50 cm
cod. 105115 ~ 90x60 cm
cod. 105116 ~ 120x70 cm

RETTANGOLARI ORIZZONTALI

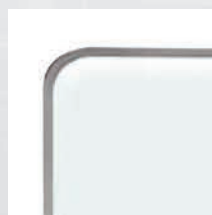

LIGHTED SIGN - RETTANGOLARE V.
cod. 105118 ~ 50x70 cm
cod. 105119 ~ 60x90 cm
cod. 105120 ~ 70x120 cm

RETTANGOLARI VERTICALI

cod. 100020 ~ PACKING COST
Costi di imballaggio per insegne.
Packing cost for sign.



PHARMACY CROSS | CROCE LED FARMACIA

Croce luminosa bifacciale per farmacia. Profilo in alluminio, bordo con circuito elettrico. Illuminazione LED.

- Dimensioni: 90x90x15 cm.
- Attivazione con telecomando
- Tipo 1: Caduceo
- Tipo 2: Data-Ora-Temperatura

Lighted pharmacy cross, double sided. Made of luminum with LED lights.

- Activating with the remote control
- Sizes: 90x90x15 cm.
- Type 1: Caduceus
- Type 1: Date-Time-Temperature

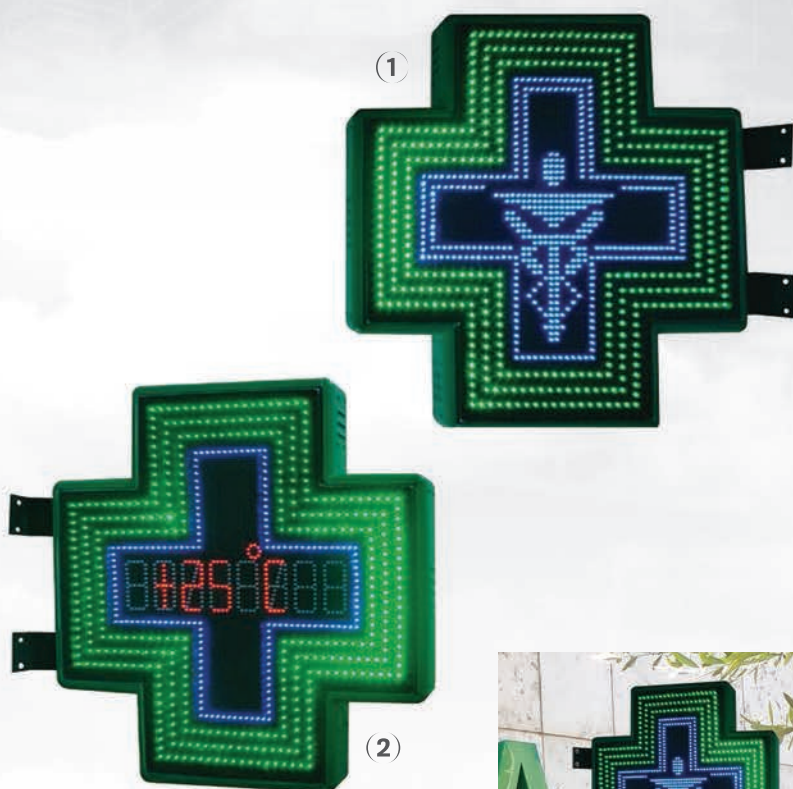

CADUCEO
① cod. 105121

DATA - ORA - TEMPERATURA
② cod. 105122

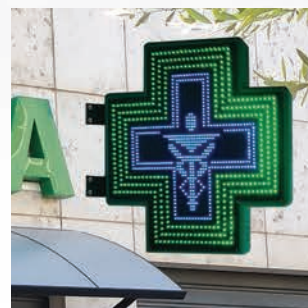

LIGHTED BOX | CASSONETTO LUMINOSO

Cassonetto luminoso monofacciale. Struttura in alluminio, con pannello opalino.

- Dimensioni: 80x200x10 cm.
- Altre dimensioni su richiesta
- Prodotto neutro - Stampa non inclusa

Lighted box single sided. Made of aluminium and opalino panel.

- Sizes: 80x200x10 cm.
- Other sizes available on request
- Print not included



cod. 105123 ~ 80x200 cm.



DANDY | TOTEM BIFACCIALE

Totem bifacciale con base in ferro verniciato. Struttura realizzata in alluminio satinato. Pannelli opalino.

- Formati: 60x180 e 80x200 cm.
- Disponibili Luminosi e Non Luminosi.
- Prodotto neutro - Stampa non inclusa

Double sided Totem. Made of brushed aluminum, base made of iron. Opaline panels.

- Sizes: 60x180 and 80x200 cm.
- Available Lighted and Not Lighted
- Print not included

DANDY - LIGHT	
cod. 105128	~ 60x180 cm
cod. 105129	~ 80x200 cm



DANDY - NOT LIGHT	
cod. 105130	~ 60x180 cm
cod. 105131	~ 80x200 cm

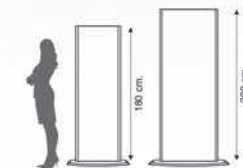
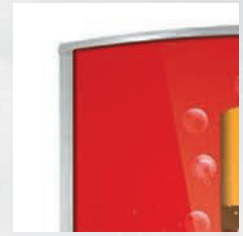

SLIM | TOTEM BIFACCIALE

Totem bifacciale luminoso. Struttura realizzata in alluminio satinato con base in lamiera. Pannelli opalino.

- Formato: 35x150 cm.
- Totem Luminoso.
- Prodotto neutro - Stampa non inclusa

Double sided Totem. Made of brushed aluminum, base in sheet metal and opaline panels.

- Size: 35x150 cm.
- Totem Lighted
- Print not included

cod. 105132	~ SLIM - 35x150 cm
-------------	--------------------

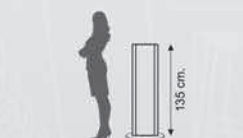
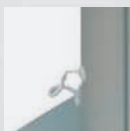



PLEXI SCATOLATO CASE IN PLEXI

Scatolato luminoso per insegne, realizzato completamente in plexi opalino che ne garantisce una elevata luminosità. La parte frontale si personalizza con adesivo prespaziato.

- Completamente in plexi opalino
- Disponibili varie forme e dimensioni
- Su richiesta lavorazioni su misura

Light box for signs, made of opaline plexi that guarantees a high brightness. The front part is customized with pre-spaced adhesive.

- Sizes and shapes available
- On request custom work



SQUADRATE *
cod. 106640 ~ 80x80 cm
cod. 106641 ~ 100x100 cm
cod. 106642 ~ 100x150 cm

TONDE *
cod. 106643 ~ Ø 80 cm
cod. 106644 ~ Ø 100 cm

OVALE *
cod. 106645 ~ 80x40 cm
cod. 106646 ~ 100x60 cm

* SU RICHIESTA EFFETTIAMO LAVORAZIONI SU MISURA



EMBLEM INSEGNE FAST FOOD

Scatolato luminoso per insegne, realizzato in metallo. Tipica insegna da interno, utilizzata nei fast food, pub o ristoranti. Personalizzazione con adesivo o backlight.

- Bifacciale
- Luce Led
- Dimensione disponibile: cm. 60x50
- Staffa di sostegno in ABS
- Stampa e supporto di stampa NON inclusi

Light box for signs, made of metal. Typical sign for indoor, used in fast food, pubs or restaurants. Personalization with adhesive or backlight.

- Double sided
- Size available: cm. 60x50
- Support bracket made of ABS
- Print and print support NOT included

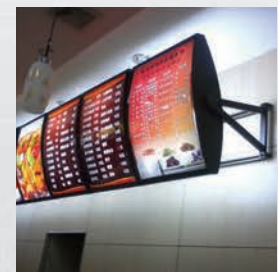

cod. 106648 ~ EMBLEM - 60x50 cm.

LED LIGHTS

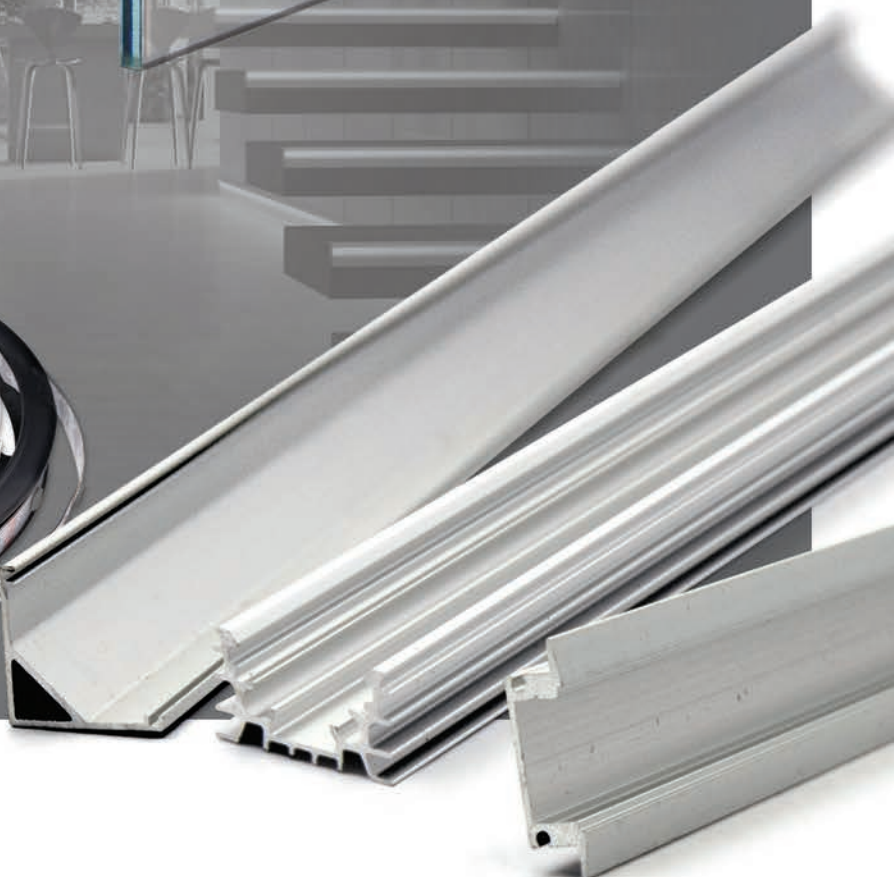
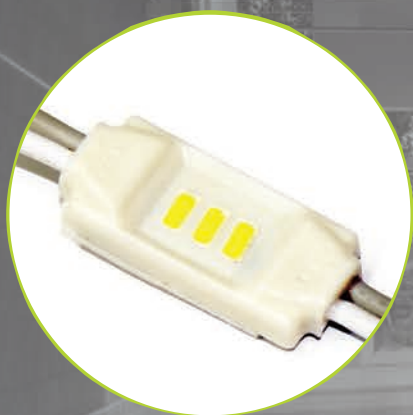

Profili, strutture e luci per realizzare soluzioni espositive ad illuminazione LED.



Profiles, structures and lights to realize display solutions for LED lighting.



MINIMODULI LED

Mini moduli LED. Composti da 3 luci led per modulo. Colore bianco freddo. Per profondità da 20 a 80 mm. Grazie alle piccole dimensioni possono essere utilizzati per lavori in spazi ridotti. Per insegne, lettere luminose, vetrine, targhe, segnalazioni e usi estetici.

- Confezione: 20 Mini Moduli. (1,45 mt.)
- Tipologia LED: 3014 SMD LED
- Colore: Cool white:10000-12000K
- Angolo di visione: 120°
- Luminosità (singolo LED): 30-35LM
- Durata: 50000h
- Tensione funzionamento: DC12V
- Potenza: 0.36W
- Massima connessione in serie: ≤30pcs
- Waterproof: IP 65
- Biadesivo 3M incluso

- Packing: 20 Mini Led Module (1,45 mt.)
- LED Type: 3014 SMD LED
- Color: Cool white:10000-12000K
- Viewing angle: 120°
- Single LED Brightness: 30-35LM
- Lifespan: 50000h
- Working Voltage: DC12V
- Power: 0.36W
- Max in serial connection: ≤30pcs
- Waterproof: IP 65
- Biadhesive 3M included

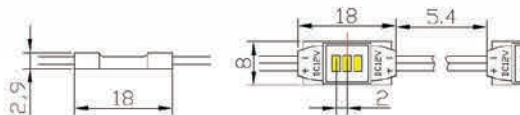
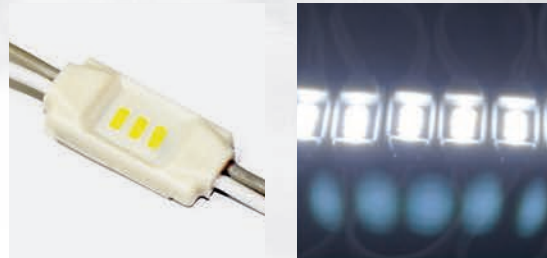

cod. 645303 ~ MINI MODULI LED

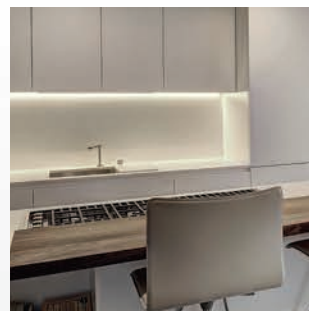

STRIP LED + ACCESSORI



- 1 cod. 645301 ~ STRIP LED 5 mt. - BIANCO FREDDO
- 2 cod. 645302 ~ STRIP LED 5 mt. - RGB



- cod. 645351 ~ MINI RGB CONTROLLER 12V 6A *
- cod. 645352 ~ MINI RGB CONTROLLER 12V 6A - 72W *

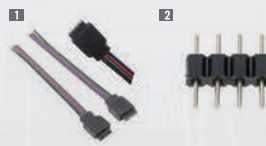

- 1 cod. 645548 ~ CONNETTORE FEMMINA RGB
- 2 cod. 645549 ~ SPINOTTO COLLEGAMENTO RGB



- cod. 645551 ~ ALIMENTATORE STRIP LED 12V - 2A
- cod. 645552 ~ ALIMENTATORE STRIP LED 12V - 5A

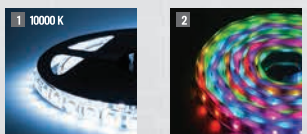

cod. 645550 ~ CONNETTORE FEMMINA ALIMENTAZIONE

*44 CHIAVI - CONTROLLO INFRAROSSI



LED PROFILE LUCI LED

Profili per sistemi di illuminazione LED. Completi di cover esterni ed accessori per l'installazione sia esterna che ad incasso. Disponibili in diverse forme, adatte per applicazioni decorative su scaffali o vetrine, per segnalazioni percorsi di emergenza o per utilizzi estetici e l'arredamento.

- Alluminio anodizzato
- Lunghezza profili e cover 200 cm.

Anodised aluminum profiles for LED lighting systems. Complete with external cover and accessories for installation. Available in different shapes, suitable for decorative applications, for emergency, routs aesthetic use to the decor, ecc.

- Anodised aluminum
- Profile and Cover lenght 200 cm.



YF102

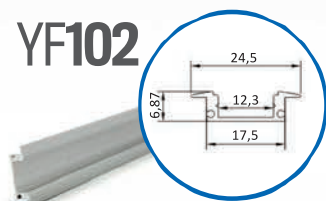

- | | | |
|--|--|---|
| 1 cod. 105900 ~ PROFILO LED YF102 - COVER BIANCA 2mt. | 3 cod. 105902 ~ CLIP PLASTICA YF102 - TRASPARENTE | 5 cod. 105903 ~ END CAP YF102 - BIANCO |
| 2 cod. 105901 ~ PROFILO LED YF102 - COVER TRASPAR. 2mt. | 4 cod. 105904 ~ CLIP PLASTICA YF102 - BIANCA | |

YF103

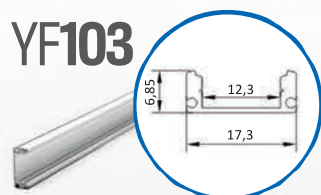

- | | | |
|--|--|---|
| 1 cod. 105905 ~ PROFILO LED YF103 - COVER BIANCA 2mt. | 3 cod. 105899 ~ CLIP PLASTICA YF103 - TRASPARENTE | 5 cod. 105907 ~ END CAP YF103 - BIANCO |
| 2 cod. 105906 ~ PROFILO LED YF103 - COVER TRASPAR. 2mt. | 4 cod. 105908 ~ CLIP PLASTICA YF103 - BIANCA | |

YF104

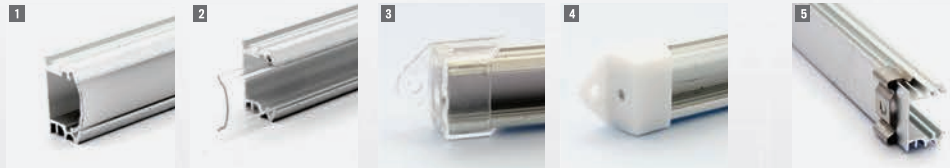
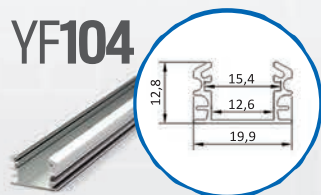

- | | | |
|--|--|---|
| 1 cod. 105909 ~ PROFILO LED YF104 - COVER BIANCA 2mt. | 3 cod. 105912 ~ END CAP YF104 - TRASPARENTE | 5 cod. 105913 ~ CLIP METALLO YF104 |
| 2 cod. 105910 ~ PROFILO LED YF104 - COVER TRASPAR. 2mt. | 4 cod. 105911 ~ END CAP YF104 - BIANCO | |

YF106

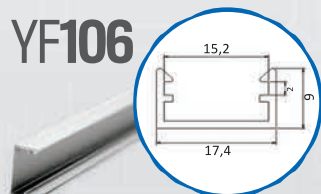

- | | | |
|---|--|---|
| 1 cod. 105914 ~ PROFILO LED YF106 - 2mt. | 2 cod. 105915 ~ END CAP YF106 - TRASPARENTE | 4 cod. 105917 ~ CLIP PLASTICA YF106 - BIANCA |
| | 3 cod. 105916 ~ END CAP YF106 - BIANCO | |

YF114

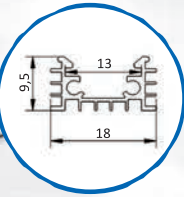

1 cod. **105918** ~ PROFILO LED YF114 - COVER BIANCA 2mt.
2 cod. **105919** ~ PROFILO LED YF114 - COVER TRASPAR. 2mt.



3 cod. **105920** ~ END CAP YF114 - TRASPARENTE
4 cod. **105921** ~ END CAP YF114 - BIANCO



5 cod. **105923** ~ METAL BRACK. ORIENT. YF114



6 cod. **105922** ~ METAL END CAP YF114
7 cod. **105924** ~ METAL END CAP SMALL YF114



8 cod. **105925** ~ CLIP METALLO YF114

YF115

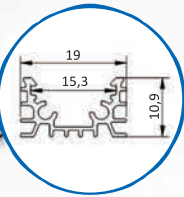

1 cod. **105926** ~ PROFILO LED YF115 - COVER BIANCA 2mt.
2 cod. **105927** ~ PROFILO LED YF115 - COVER TRASPAR. 2mt.



3 cod. **105928** ~ END CAP YF115 - TRASPARENTE
4 cod. **105929** ~ END CAP YF115 - BIANCO

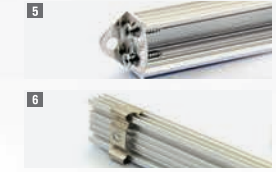

5 cod. **105930** ~ METAL END CAP YF115
6 cod. **105931** ~ CLIP METALLO YF115

YF117

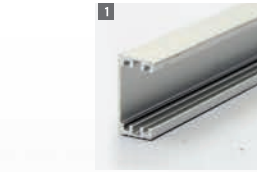
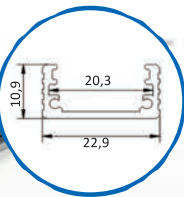

1 cod. **105932** ~ PROFILO LED YF117 - 2mt.

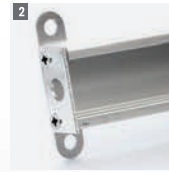

2 cod. **105933** ~ METAL END CAP YF117
3 cod. **105934** ~ SPECIAL METAL END CAP YF117

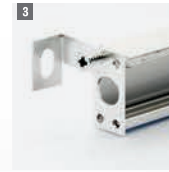

4 cod. **105935** ~ CLIP METALLO YF117

YF121

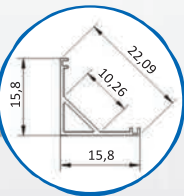

1 cod. **105936** ~ PROFILO LED YF121 - COVER BIANCA 2mt.
2 cod. **105937** ~ PROFILO LED YF121 - COVER TRASPAR. 2mt.



3 cod. **105938** ~ END CAP YF121 - BIANCO

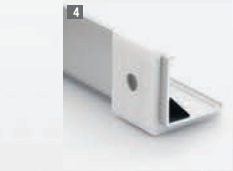

4 cod. **105939** ~ CLIP PLASTICA YF121 - BIANCO

YF128

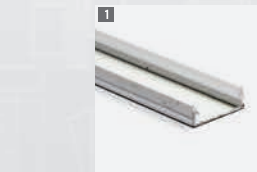
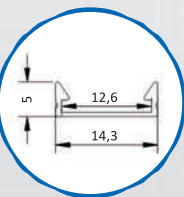

1 cod. **105940** ~ PROFILO LED YF128 - 2mt.



2 cod. **105941** ~ END CAP YF128 - TRASPARENTE
3 cod. **105942** ~ END CAP YF128 - BIANCO



4 cod. **105943** ~ CLIP PLASTICA YF128 - BIANCO



LIGHTLED | TARGHE SU PLATES | PROFILO CON LED

Targhe in plexi montate al profilo in alluminio con illuminazione LED. Ideale per messaggi pubblicitari, segnalazione percorsi, per complessi alberghieri, aree fieristiche, uffici e luoghi pubblici.

- Spessore targa 8 mm.
- Led, tappi di chiusura e ganci in plastica inclusi.
- Luce Led Bianco Freddo
- Kit per montaggio a sospensione, disponibile

Plates mounted on aluminum profile with LED illumination. Ideal for advertisements, signaling pathways, for hotel complexes, exhibition areas, offices and public places.

- Plate thickness 8 mm.
- Led, end caps and plastic hengers included
- Led Light Cold White
- for suspension, available.



cod. 100217 ~ 30x15 cm.
cod. 100218 ~ 30x20 cm.
cod. 100219 ~ 30x30 cm.
cod. 100220 ~ 40x30 cm.

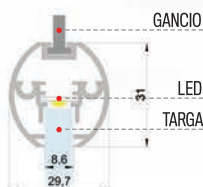

TARGHE STAMPATE SU RICHIESTA
PRINTED PLATES ON REQUEST



PLEXI | TARGA LED | LUMINOSA LED

Targa luminosa, composta da fondo in opalino da 5 mm, pannello frontale trasparente da 2 mm con cornice adesiva rifrangente. La stampa, su carta o backlight si inserisce tra i due pannelli bloccati da distanziali in acciaio satinato.

- Per uso interno
- Impianto LED incluso
- Disponibili varie forme e dimensioni
- Montaggio sia verticale che orizzontale
- Distanziali Ø.10x35 mm Inclusi

Lighted plate, composed of opaline back panel 5 mm. with LED system, transparent front panel 2 mm. with reflective adhesive. The message, on paper or backlight is placed between the two panels blocked by brushed steel standoffs.

- Use indoor
- Many sizes and shapes available
- Portrait or landscape mounting
- Standoffs Ø.10x35 mm. - Included



RETTANGOLARI
cod. 100223 ~ 29,7x42 cm
cod. 100224 ~ 42,8x59,5 cm
cod. 100225 ~ 59,5x84 cm
cod. 100226 ~ 70x100 cm



TONDE
cod. 100229 ~ Ø 40 cm
cod. 100230 ~ Ø 60 cm



OVALE
cod. 100231 ~ 70x40 cm
cod. 100232 ~ 100x50 cm



LIGHT LED FRAME | CORNICE LUMINOSA LED

Cornice a scatto con illuminazione led. Alta luminosità ottenuta grazie allo speciale fondo in acrilico che rende omogenea la luce. Il pulsante on-off e l'alimentatore esterno contribuiscono a dare lunga vita al prodotto. Svariati utilizzi possibili. Sostituzione veloce del messaggio grazie all'apertura click-clack.

- Profilo 25 mm. - Profondità 19 mm.
- Angolo Vivo
- Interruttore ON-OFF
- Sistema click-clack
- Luminosità brillante e omogenea
- 2 Ganci per fissaggio a parete inclusi

- Profile 25 mm. - Depth 19 mm.
- Mitred corner
- ON-OFF Button
- Click-clack system
- Homogenous and brilliant
- 2 wall hangers included

cod. 100589 ~ LIGHT LED FRAME 50x70 | 2900 ~ 3200 LUX

cod. 100590 ~ LIGHT LED FRAME 70x100 | 2500 ~ 2800 LUX

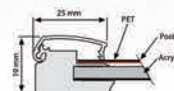
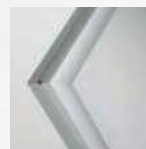
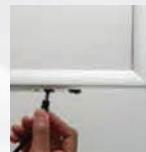

LED PANEL FRAME | CORNICE PER PLEXI&LED

Cornice realizzata con particolare profilo in alluminio. All'interno del profilo possono essere montati i led. Per il fondo si consiglia l'utilizzo di un pannello di PMMA trasparente che favorirebbe la propagazione della luce. Una soluzione di alto impatto visivo e dagli svariati utilizzi.

- Profilo 24,4 mm. - Profondità 19 mm.
- Angolo Vivo
- Fondo in PMMA - NON incluso
- LED - NON inclusi

- Profile 24,4 mm. - Depth 19 mm.
- Mitred corner
- Panel of PMMA - NOT included
- LED - NOT included



UTILIZZO CONSIGLIATO



cod. 100598 ~ LED PANEL FRAME 50x70

cod. 100599 ~ LED PANEL FRAME 70x100

MINI MODULI LED



cod. 645303
confezione 20 pz (1,45 mt)

ALIMENTATORE PER LED



cod. 645551 ~ 12V - 2A
cod. 645552 ~ 12V - 5A

CONNETTORE PER ALIMENTATORE



cod. 645550

PANNELLI PMMA



cod. 101034 ~ PMMA 50x70 - 8mm.
cod. 101035 ~ PMMA 70x100 - 8mm.

SUSPENSION SYSTEM - MAGIC



**Elementi per sistemi espositivi su cavo.
Per esporre sia in verticale che orizzontale.**



Elements for display systems on cable.
To expose portrait or landscape.



FLAT | TIRANTE SUPERIORE

Tirante snodato superiore in alluminio. Colore argento satinato. Utilizzare con Key 5 (non incluso).

Aluminium top wall fitting for stainless steel cable. Use with Key 5 (not included).

cod. 104001 ~ FLAT - TOP



- BOX:** 12 pz. [18,5x10x6 cm - 0,670 Kg]
- CTN:** 72 pz. [32x20,5x15 cm - 4,150 Kg]



UNDER | TIRANTE INFERIORE

Tirante snodato inferiore in alluminio. Colore argento satinato. Utilizzare con Key 4 (non incluso).

Aluminium under wall fitting for stainless steel cable. Use with Key 4 (not included).

cod. 104002 ~ UNDER



- BOX:** 12 pz. [18,5x10x6 cm - 0,720 Kg]
- CTN:** 72 pz. [32x20,5x15 cm - 4,450 Kg]

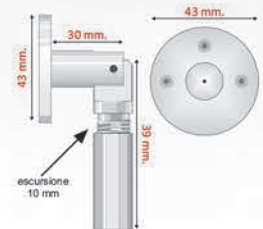

MAGIC | TIRANTE FISSO SUPERIORE

Tirante fisso superiore in alluminio. Colore argento satinato. Utilizzare con Key 4 (non incluso).

Aluminium top wall fitting for stainless steel cable. Use with Key 4 (not included).

cod. 104003 ~ MAGIC - TOP

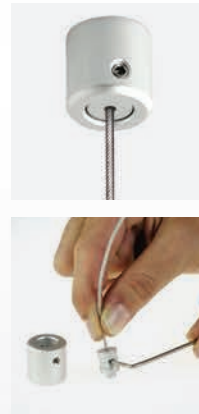

- BOX:** 40 pz. [18,5x10x6 cm - 0,570 Kg]
- CTN:** 240 pz. [32x20,5x15 cm - 3,600 Kg]



PULLS | TIRANTE FISSO INFERIORE

Tirante fisso inferiore in alluminio. Colore argento satinato. Utilizzare con Key 5 (non incluso).

Aluminium under wall fitting for stainless steel cable. Use with Key 5 (not included).

cod. 104004 ~ PULLS



- BOX:** 40 pz. [18,5x10x6 cm - 1,350 Kg]
- CTN:** 240 pz. [32x20,5x15 cm - 8,400 Kg]

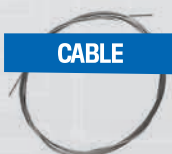

CABLE

Cavo in acciaio con guaina trasparente. Ø 1,5 mm.
Steel cable. Ø 1,5 mm.

- cod. 104170 ~ 1 mt.
- cod. 104172 ~ 100 mt.

ALLEN KEY

Chiavini esagonale per distanziali
Allen keys for standoffs

- cod. 103501 ~ KEY 5
- cod. 103502 ~ KEY 4



SINKER | CONTRAPPESO INFERIORE

Contrappeso in alluminio

- Peso 520 gr.
- da utilizzare con Key 5 (non incluso)

Sinker for cable system

- Weight 520 gr.
- use with Key 5 (not included)

cod. 104021 ~ SINKER



 • **CTN:** 25 pz.
[32x20,5x15 cm - 11,300 Kg]





CLOUD | MORSETTO PORTA PANNELLI

Morsetto portapannelli in alluminio per sistema su cavo MAGIC. Il fissaggio del pannello avviene grazie al sistema a brugola, da utilizzare con Key 5 + Key 4 (non incluso).

panel support for cable system MAGIC. Use with Key 5 + Key 4 (not included).

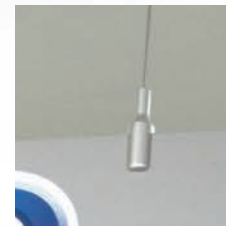
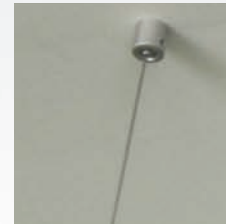
cod. 104013 ~ CLOUD



 • **BOX:** 60 pz.
[18,5x10x6 cm - 0,830 Kg]
 • **CTN:** 360 pz.
[32x20,5x15 cm - 5,100 Kg]



GLOBE | FERMACAVO

Fermacavo in alluminio satinato con bloccaggio a brugola. Da utilizzare con Key 4 (non incluso).

- Diametro 12 mm

Loop clamp for cable. Use with Key 4 (not included).

- Diameter 12 mm

cod. 104014 ~ GLOBE

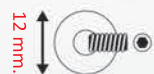

WIRE | FERMACAVO

Fermacavo a coppia in alluminio. Chiusura a pressione.

- 2 pezzi per confezione
- Dimensioni 6x4x9 mm

Loop clamp for cable.

- 2 pieces
- Sizes 6x4x9 mm

cod. 103503 ~ WIRE - 2pz.

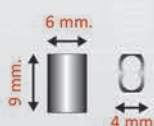



TONG | PINZA SINGOLA PER TASCHE

Pinza singola per tasche. Realizzata in alluminio, colore argento satinato. Da utilizzare con Key 5 (non incluso).

Lateral support for pocket for cable system. Fixing of panel and cable with allen screws. Use with Key 5 (not included).

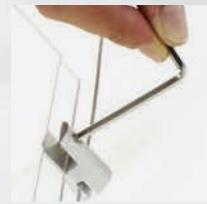

- BOX:** 60 pz. [18,5x10x6 cm - 0,700 Kg]
- CTN:** 360 pz. [32x20,5x15 cm - 4,480 Kg]

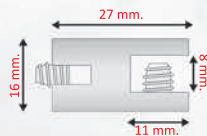

cod. 104010 ~ TONG



TONG DOUBLE | PINZA DOPPIA PER TASCHE

Pinza doppia per tasche. Realizzata in alluminio, colore argento satinato. Da utilizzare con Key 5 (non incluso).

Double Lateral support for pocket for cable system. Fixing of panel and cable with allen screws. Use with Key 5 (not included).

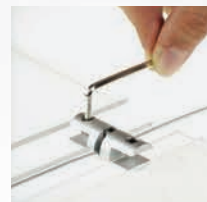
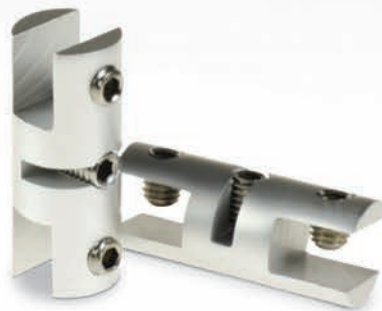

- BOX:** 60 pz. [18,5x10x6 cm - 0,900 Kg]
- CTN:** 360 pz. [32x20,5x15 cm - 5,520 Kg]

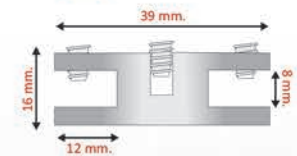

cod. 104011 ~ TONG DOUBLE



POKET | TASCHE PER SISTEMA MAGIC

Tasche portamessaggi in acrilico colato trasparente. Per sistema Magic.

Poket it's a new product for show your message. Clear acrylic. For Magic system.

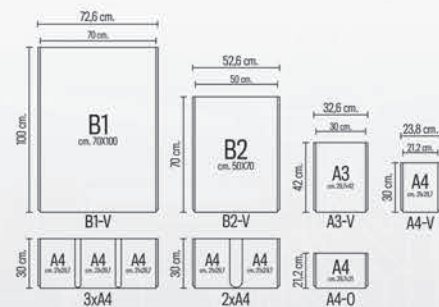

- cod. 104031 ~ POKET A4 - VERTICALE/PORTRAIT
- cod. 104032 ~ POKET A4 - ORIZZONTALE/LANDSCAPE
- cod. 104033 ~ POKET 2x A4 - VERTICALE/PORTRAIT
- cod. 104034 ~ POKET 3x A4 - VERTICALE/PORTRAIT
- cod. 104035 ~ POKET A3 - VERTICALE/PORTRAIT
- cod. 104036 ~ POKET B2 - cm. 50x70 - VERTICALE/PORTRAIT *
- cod. 104037 ~ POKET B1 - cm. 70x100 - VERTICALE/PORTRAIT *

*Costi di imballaggio / *Packing cost

cod. 104040 ~ PACKING COST *

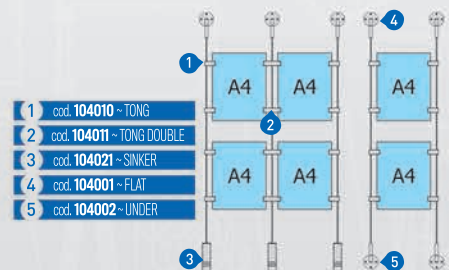

KIT MAGIC

SISTEMI ESPOSITIVI
A TASCHE SU CAVO

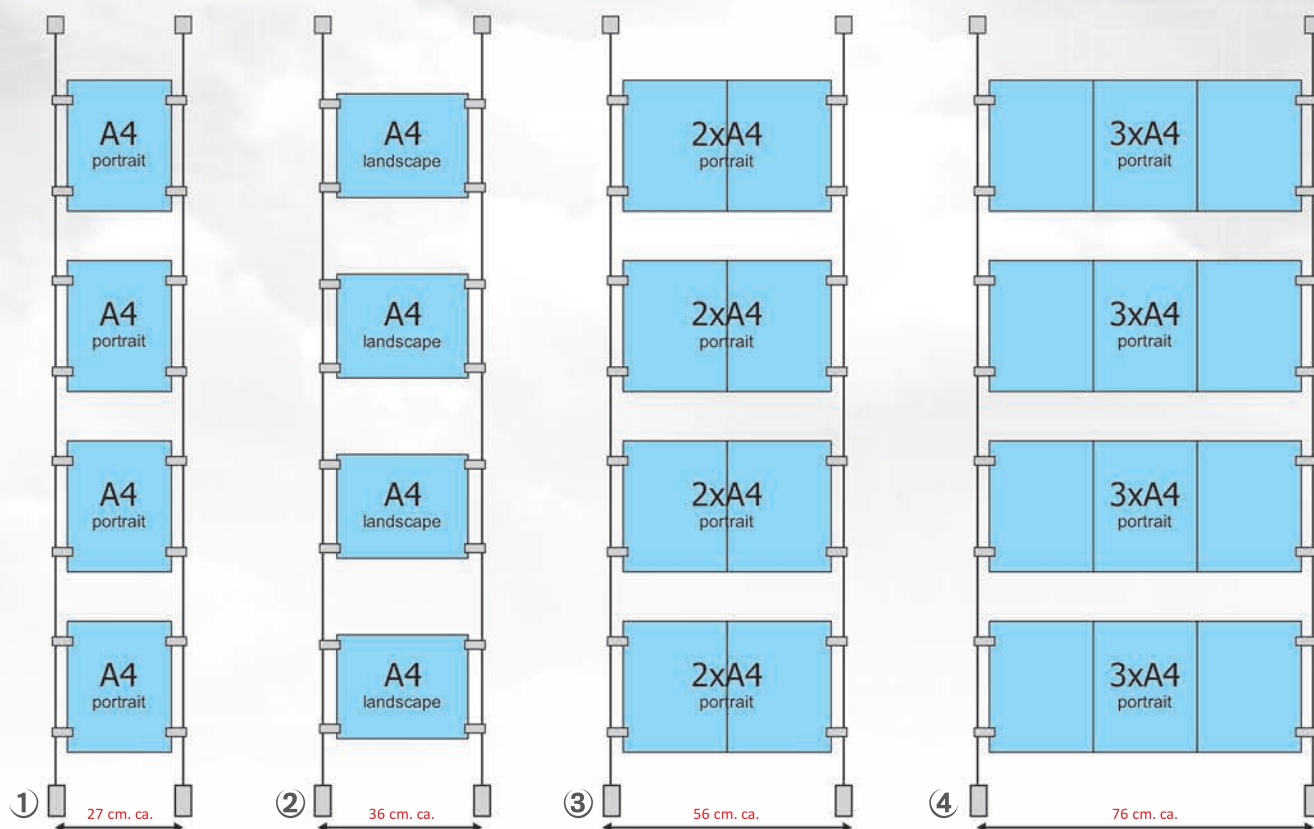

KITMAGIC BERLINO

SOFFITTO/PAVIMENTO

- 2x 104003 ~ TIRANTE MAGIC
- 2x 104004 ~ TIRANTE PULLS
- 16x 104010 ~ TONG - PINZA SINGOLA
- 4x 104031 ~ POKET A4 - TASCA VERT.
- 2x CABLE - CAVO 400 cm.

KITMAGIC PRAGA

SOFFITTO/PAVIMENTO

- 2x 104003 ~ TIRANTE MAGIC
- 2x 104004 ~ TIRANTE PULLS
- 16x 104010 ~ TONG - PINZA SINGOLA
- 4x 104032 ~ POKET A4 - TASCA ORIZZ.
- 2x CABLE - CAVO 400 cm.

KITMAGIC BORA BORA

SOFFITTO/PAVIMENTO

- 2x 104003 ~ TIRANTE MAGIC
- 2x 104004 ~ TIRANTE PULLS
- 16x 104010 ~ TONG - PINZA SINGOLA
- 4x 104033 ~ POKET 2xA4 - TASCA VERT.
- 2x CABLE - CAVO 400 cm.

KITMAGIC AMSTERDAM

SOFFITTO/PAVIMENTO

- 2x 104003 ~ TIRANTE MAGIC
- 2x 104004 ~ TIRANTE PULLS
- 16x 104010 ~ TONG - PINZA SINGOLA
- 4x 104034 ~ POKET 3xA4 - TASCA VERT.
- 2x CABLE - CAVO 400 cm.

① cod. 104121 ~ BERLINO - KIT MAGIC

② cod. 104101 ~ PRAGA - KIT MAGIC

③ cod. 104141 ~ BORA BORA - KIT MAGIC

④ cod. 104151 ~ AMSTERDAM - KIT MAGIC

È POSSIBILE IMPILARE TASCHE
POKET DI FORMATI DIVERSI





POLE MAGIC | SISTEMA A CAVO SU PALI PER TASCHE

Struttura composta da doppio palo di sostegno in alluminio, traverse e basi in ferro verniciate. Applicata alla struttura sistema espositivo a cavo con tasche. Tante soluzioni possibili.

- Larghezza traversi: 40, 85 e 150 cm
- Pali: H.200 cm. - Basi: Ø.30 cm.
- Fornito Smontato

Aluminium structure with iron bases. Applied suspension display system. Many solutions available.

- 2x) Pole: H.200 cm. - 2x) Base: Ø.30 cm.
- Unassembled



COMPONENTI



- 1 cod. 102703 ~ EASY STAND PROFILE - 200 cm.
- 2 cod. 102702 ~ EASY STAND BASE - Ø 30 cm.
- 3 cod. 102704 ~ EASY END CAP
- 4 cod. 104030 ~ MAGIC POLE PLATE + VITE



- cod. 104027 ~ TRAVERSO EASY 40
- cod. 104028 ~ TRAVERSO EASY 85
- cod. 104029 ~ TRAVERSO EASY 150

REALIZZA IL TUO MAGIC POLE IN BASE ALLE TUE ESIGENZE

MAGIC



cod. 104003 ~ MAGIC-TOP

PULLS



cod. 104004 ~ PULLS

TONG



cod. 104010 ~ TONG

TONG DOUBLE



cod. 104011 ~ TONG DOUBLE

CABLE



cod. 104170 ~ 1mt. - Ø 1,5 mm
cod. 104172 ~ 100 mt. - Ø 1,5 mm

ALLENKEY



cod. 103501 ~ KEY 5
cod. 103502 ~ KEY 4

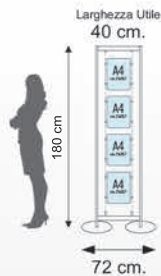

cod. 104173 ~ MAGIC POLE - 40

- 2x 102702 ~ EASY STAND BASE
- 2x 102703 ~ EASY STAND PROFILE
- 2x 102704 ~ EASY END CAP
- 2x 104027 ~ TRAVERSO EASY - 40
- 2x 104003 ~ MAGIC - TIRANTE TOP
- 2x 104004 ~ PULLS - TIRANTE BOTTOM
- 4x 104030 ~ MAGIC POLE PLATE + VITE
- 16x 104010 ~ TONG - PINZA SINGOLA
- 4x 104031 ~ TASCIA POKET A4 - VERTICALE



cod. 104174 ~ MAGIC POLE - 85

- 2x 102702 ~ EASY STAND BASE
- 2x 102703 ~ EASY STAND PROFILE
- 2x 102704 ~ EASY END CAP
- 2x 104028 ~ TRAVERSO EASY - 85
- 2x 104003 ~ MAGIC - TIRANTE TOP
- 2x 104004 ~ PULLS - TIRANTE BOTTOM
- 4x 104030 ~ MAGIC POLE PLATE + VITE
- 10x 104010 ~ TONG - PINZA SINGOLA
- 1x 104037 ~ TASCIA POKET 70x100 - VERTICALE
- 1x 104034 ~ TASCIA POKET 3xA4 - VERTICALE



cod. 104175 ~ MAGIC POLE - 150

- 2x 102702 ~ EASY STAND BASE
- 2x 102703 ~ EASY STAND PROFILE
- 2x 102704 ~ EASY END CAP
- 2x 104029 ~ TRAVERSO EASY - 150
- 6x 104003 ~ MAGIC - TIRANTE TOP
- 6x 104004 ~ PULLS - TIRANTE BOTTOM
- 12x 104030 ~ MAGIC POLE PLATE + VITE
- 16x 104010 ~ TONG - PINZA SINGOLA
- 32x 104011 ~ TONG DOUBLE - PINZA DOPIA
- 20x 104031 ~ TASCIA POKET A4 - VERTICALE

POKET

- cod. 104031 ~ POKET A4 - VERTICALE/PORTRAIT
- cod. 104032 ~ POKET A4 - ORIZZONTALE/LANDSCAPE
- cod. 104033 ~ POKET 2xA4 - VERTICALE/PORTRAIT
- cod. 104034 ~ POKET 3xA4 - VERTICALE/PORTRAIT
- cod. 104035 ~ POKET A3 - VERTICALE/PORTRAIT
- * cod. 104036 ~ POKET B2 - cm. 50x70 - VERTICALE/PORTRAIT
- * cod. 104037 ~ POKET B1 - cm. 70x100 - VERTICALE/PORTRAIT

*Costi di imballaggio/Packing cost
* cod. 104040 ~ PACKING COST



È POSSIBILE IMPILARE TASCHE POKET DI FORMATI DIVERSI



SHEL | PINZA SINGOLA PER RIPIANI

Pinza singola per ripiani. Realizzata in alluminio, colore argento satinato. Da utilizzare con Key 5 (non incluso).

Lateral support for panel, for cable system. Fixing of panel and cable with allen screws. Use with Key 5 (not included).

cod. 104016 ~ SHEL



- **BOX:** 60 pz. [18,5x10x6 cm - 0,700 Kg]
- **CTN:** 360 pz. [32x20,5x15 cm - 4,480 Kg]

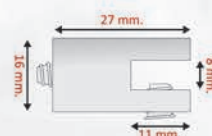

SHEL DOUBLE | PINZA DOPPIA PER RIPIANI

Pinza doppia per ripiani. Realizzata in alluminio, colore argento satinato. Da utilizzare con Key 5 (non incluso).

Double lateral support for panels, for cable system. Fixing of panel and cable with allen screws. Use with Key 5 (not included).

cod. 104017 ~ SHEL DOUBLE

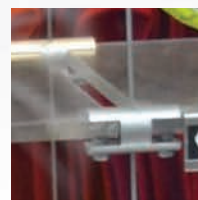

- **BOX:** 60 pz. [18,5x10x6 cm - 0,900 Kg]
- **CTN:** 360 pz. [32x20,5x15 cm - 5,520 Kg]

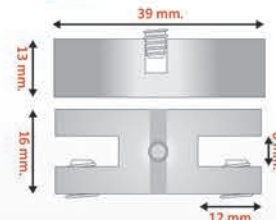

SHELF | RIPIANO IN ACRILICO TRASPARENTE

Ripiano in metacrilato trasparente. Utilizzo con pinze per ripiani su sistema a cavo.

- Spessore 5 mm.
- Dimensione 40x20 cm.

Shelf made of clear acrylic for cable system.

- Thickness 5 mm.
- Size 40x20 cm.

cod. 101031 ~ SHELF

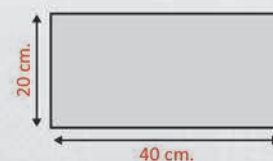

KIT SHEL

SISTEMI ESPOSITIVI
A RIPIANI SU CAVO

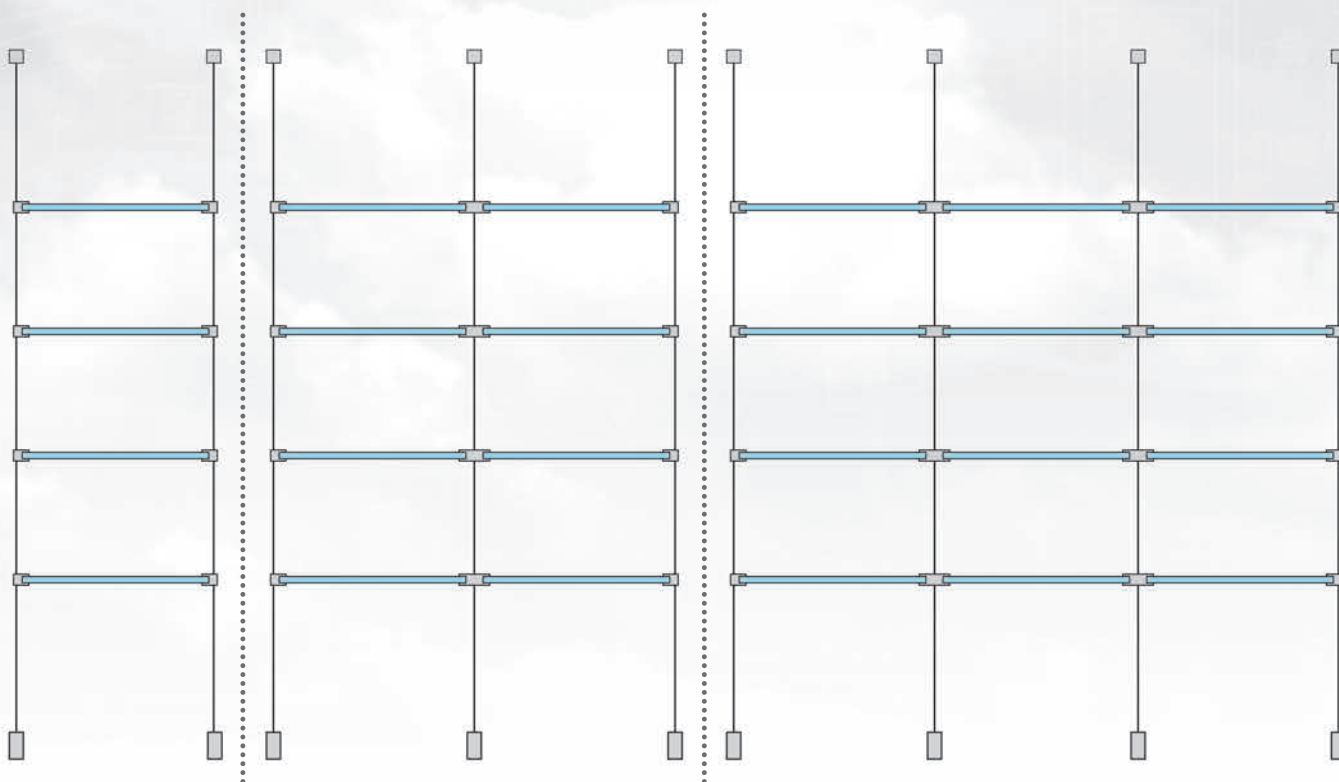

①

KIT SHEL MIRAFLORES

SOFFITTO/PAVIMENTO

- 4x 104003 ~ TIRANTE MAGIC
- 2x 104004 ~ TIRANTE PULLS
- 16x 104016 ~ SHEL - PINZA SINGOLA
- 4x 101031 ~ SHEL - RIPIANO
- 4x CABLE - CAVO 300 cm.

②

KIT SHEL AREQUIPA

SOFFITTO/PAVIMENTO

- 6x 104003 ~ TIRANTE MAGIC
- 6x 104004 ~ TIRANTE PULLS
- 16x 104016 ~ SHEL - PINZA SINGOLA
- 8x 104017 ~ SHEL - PINZA DOPPIA
- 8x 101031 ~ SHEL - RIPIANO
- 6x CABLE - CAVO 300 cm.

③

KIT SHEL CUZCO

SOFFITTO/PAVIMENTO

- 8x 104003 ~ TIRANTE MAGIC
- 8x 104004 ~ TIRANTE PULLS
- 16x 104016 ~ SHEL - PINZA SINGOLA
- 16x 104017 ~ SHEL - PINZA DOPPIA
- 12x 101031 ~ SHEL - RIPIANO
- 8x CABLE - CAVO 300 cm.

1) cod. 104181 ~ MIRAFLORES - KIT SHEL

2) cod. 104182 ~ AREQUIPA - KIT SHEL

3) cod. 104183 ~ CUZCO - KIT SHEL



OSDISPLAYS



Sistemi espositivi per uffici e negozi.



Display systems for offices and shop.



CORK OFFICE BOARD | BACHECA A GIORNO IN SUGHERO

Bacheca a giorno per utilizzo da interno. Fondo in sughero, sono dotate di cornice in alluminio. E' possibile utilizzare le bacheche sia in orizzontale che in verticale.

Cork office board for indoor use, in different sizes can be used in portrait or landscape positions.



CORK OFFICE BOARD A4	
	cod. 104601 ~ A4 - cm. 21x29,7
	cod. 104602 ~ A3 - cm. 42x29,7
*	cod. 104603 ~ A2 - cm. 59x42 - 4x A4
*	cod. 104604 ~ cm 60x90 - 8x A4
*	cod. 104605 ~ cm 90x120 - 16x A4
**	cod. 104606 ~ cm 90x180 - 24x A4



MAGNETIC OFFICE BOARD | BACHECA A GIORNO MAGNETICA

Bacheca a giorno per utilizzo da interno, fondo magnetico/scrivibile. Sono dotate di cornice in alluminio. E' possibile utilizzare le bacheche sia in orizzontale che in verticale.

Magnetic office board for indoor use, in different sizes can be used in portrait or landscape positions.



MAGNETIC OFFICE BOARD	
*	cod. 104621 ~ A2 - cm. 59x42 - 4x A4
*	cod. 104622 ~ cm 60x90 - 8x A4
*	cod. 104623 ~ cm 90x120 - 16x A4
**	cod. 104624 ~ cm 90x180 - 24x A4



* cod. **100020** ~ PACKING COST

*Costi di imballaggio per le bacheche.
*Packing cost for office board.

** cod. **104661** ~ PACKING COST

**Costi di imballaggio per le bacheche 90x180
**Packing cost for office board 90x180

MARKER

- cod. **920020** ~ BLACK
- cod. **920021** ~ BLUE
- cod. **920022** ~ RED
- cod. **920023** ~ GREEN

Pennarelli ad acqua
Dry wipe markers



MAGNET

Magneti 3cm. Col. Ass.
Magnet 3 cm. Mix Col.



cod. **920011** ~ 5 PCS



CORK SHOW BOARD

BACHECA CON ANTA IN SUGHERO

Bacheca completa di anta con pvc trasparente, fondo in sughero e serratura con chiave. Utilizzo in verticale e in orizzontale. Per uso interno o esterno

Cork show board for indoor and outdoor use. Cork backing. The cover can be opened 90 degrees.



CORK SHOW BOARD

* cod. 104631 ~ cm 48x65 - 4x44 ~ Esterno: cm 58,5x75,5

* cod. 104632 ~ cm 59x108 - 6x44

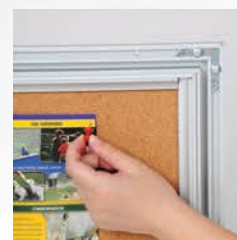

MAGNETIC SHOW BOARD

BACHECA CON ANTA MAGNETICA

Bacheca completa di anta con pvc trasparente, serratura con chiave e fondo magnetico/scrivibile. Utilizzo in verticale e in orizzontale. Per uso interno o esterno

Magnetic show board for indoor and outdoor use. Magnetic backing. Cover can be opened 90 degrees.



MAGNETIC SHOW BOARD

* cod. 104641 ~ cm 48x65 - 4x44 ~ Esterno: cm 58,5x75,5

* cod. 104642 ~ cm 59x108 - 6x44



* cod. 100020 ~ PACKING COST

*Costi di imballaggio per tutte le bacheche.
*Packing cost for all office board.

MARKER

cod. 920020 ~ BLACK

cod. 920021 ~ BLUE

cod. 920022 ~ RED

cod. 920023 ~ GREEN

Pennarelli ad acqua
Dry wipe markers



MAGNET

Magneti 3cm. Col. Ass.
Magnet 3 cm. Mix Col.



cod. 920011 ~ 5 PCS



BUSINESS CARD HOLDER | PORTA BIGLIETTI DA VISITA

Porta biglietti da visita. Realizzati in PMMA. Disponibili diverse soluzioni.

- Disponibili trasparenti e colorati
- Sia a tasca singola che multitasca
- Orizzontali e verticali

Business card holder. Made from PMMA. Available many solutions.

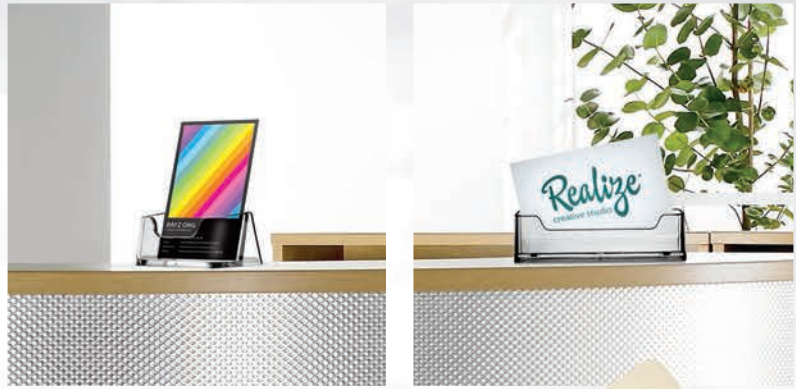

1 TASCA ORIZZONTALE

cod. 106122 ~ TRASPARENTE

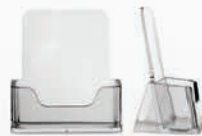
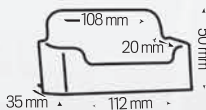

1 TASCA VERTICALE

cod. 106132 ~ TRASPARENTE

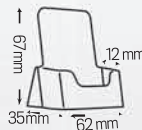

4 TASCHE ORIZZONTALI

cod. 106142 ~ TRASPARENTE

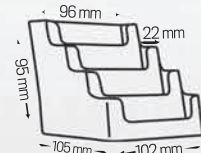

1 TASCA ORIZZONTALE - COLORATI

cod. 106123 ~ ARANCIO

cod. 106124 ~ ACQUAMARINA

cod. 106125 ~ MAGENTA

cod. 106126 ~ VERDE

cod. 106127 ~ BLU ELETTRICO

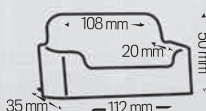

2 TASCHE VERTICALE

cod. 106141 ~ TRASPARENTE

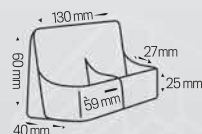



BROCHURE HOLDER | PORTA DEPLIANT DA BANCO

1/3 A4

Portadepliant da banco 1/3 di A4. Realizzati in PMMA. Disponibili diverse soluzioni.

- Disponibili trasparenti e colorati
- Sia a tasca singola che multitasca

Brochure holder 1/3rd A4. Made from PMMA. Available many solutions.

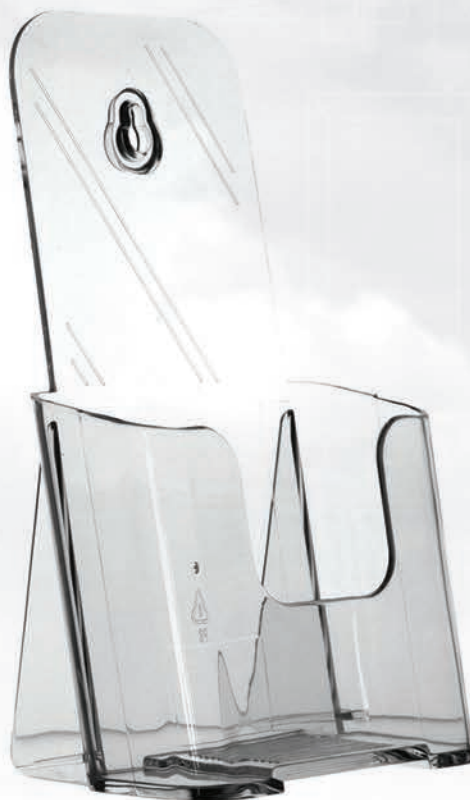

1 TASCA VERTICALE

① cod. 106152 ~ TRASPARENTE

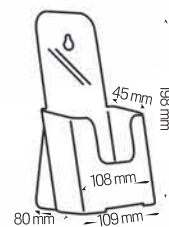

1 TASCA VERTICALE - COLORATI

- ② cod. 106153 ~ ARANCIO
- ③ cod. 106154 ~ ACQUAMARINA
- ④ cod. 106155 ~ MAGENTA
- ⑤ cod. 106156 ~ VERDE
- ⑥ cod. 106157 ~ BLU ELETTRICO

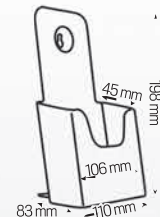

2 TASCHE VERTICALI

cod. 106163 ~ TRASPARENTE

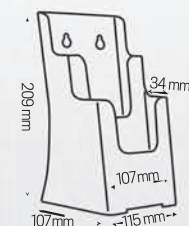

4 TASCHE VERTICALI

cod. 106165 ~ TRASPARENTE

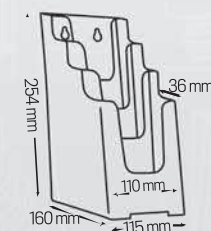
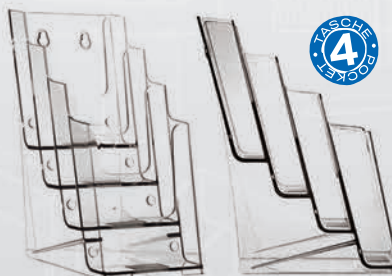



BROCHURE HOLDER | PORTA DEPLIANT DA BANCO A5

Portadepliant da banco A5. Realizzati in PMMA. Disponibili diverse soluzioni.

- Disponibili trasparenti e colorati
- Sia a tasca singola che multitasca

Brochure holder A5. Made from PMMA. Available many solutions.



1 TASCA VERTICALE

① cod. 106172 ~ TRASPARENTE

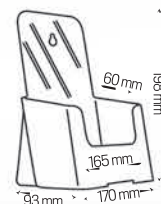

1 TASCA VERTICALE - COLORATI

- ② cod. 106173 ~ ARANCIO
- ③ cod. 106174 ~ ACQUAMARINA
- ④ cod. 106175 ~ MAGENTA
- ⑤ cod. 106176 ~ VERDE
- ⑥ cod. 106177 ~ BLU ELETTRICO

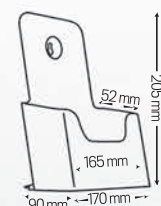

4 TASCHE VERTICALI

cod. 106184 ~ TRASPARENTE

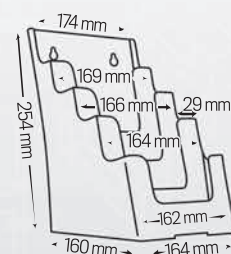

1 TASCA ORIZZONTALE

cod. 106192 ~ TRASPARENTE

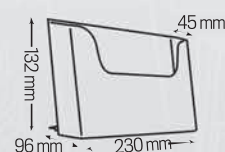



BROCHURE HOLDER | PORTA DEPLIANT DA BANCO

A4

Portadepliant da banco A4. Realizzati in PMMA. Disponibili diverse soluzioni.

- Disponibili trasparenti e colorati
- Sia a tasca singola che multitasca

Brochure holder A4. Made from PMMA. Available many solutions.



1 TASCA VERTICALE

① cod. 106185 ~ TRASPARENTE

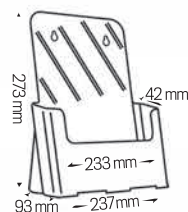

1 TASCA VERTICALE - COLORATI

- ② cod. 106193 ~ ARANCIO
- ③ cod. 106194 ~ ACQUAMARINA
- ④ cod. 106195 ~ MAGENTA
- ⑤ cod. 106196 ~ VERDE
- ⑥ cod. 106197 ~ BLU ELETTRICO

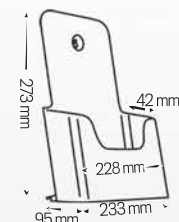

3 TASCHE VERTICALI

cod. 106203 ~ TRASPARENTE

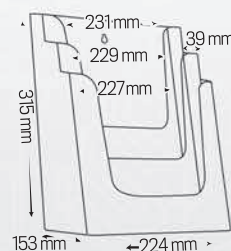

4 TASCHE VERTICALI

cod. 106204 ~ TRASPARENTE

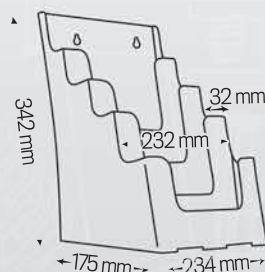



BROCHURE HOLDER | PORTA DEPLIANT DA PARETE WALL MOUNTING

Portadepliant da Parete. Realizzati in PMMA trasparente. Disponibili diverse soluzioni.

- 3 Formati disponibili
- Complete di fori per affissione
- Possono essere montati anche su pali

Brochure holder wall mounting. Made from PMMA. Available many solutions.



WMBHDL - 1/3 A4
cod. 106211 - TRASPARENTE

1/3
A4

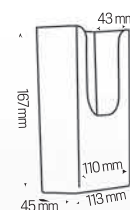

WMBHA5 - A5
cod. 106212 - TRASPARENTE

A5

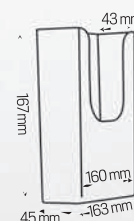

WMBHA4 - A4
cod. 106213 - TRASPARENTE

A4

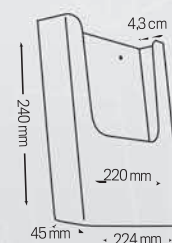



LEAFLET HOLDER | PORTA AVVISI BIFACCIALE

DOUBLE SIDED

Porta avvisi / messaggi bifacciale da banco completamente trasparente. Il messaggio si inserisce facilmente nell'apposita tasca. Realizzato in acrilico trasparente.

- Disponibili orizzontali o verticali
- Vari formati disponibili

Double Sided leaflet holder, completely transparent. The message fits easily in the pocket. Made from PMMA.

- Landscape or portrait
- Many sizes available



54x85 VERTICALE

cod. 106219 ~ TRASPARENTE

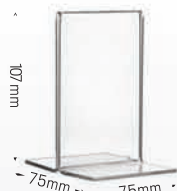

74x105 VERTICALE

cod. 106220 ~ TRASPARENTE



1/3 A4 - VERTICALE

cod. 106221 ~ TRASPARENTE



A5 VERTICALE

cod. 106222 ~ TRASPARENTE



A4 VERTICALE

cod. 106223 ~ TRASPARENTE

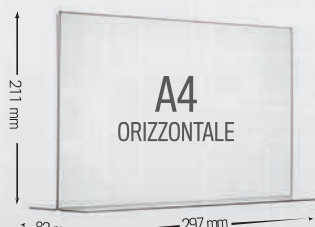

A4 - ORIZZONTALE

cod. 106224 ~ TRASPARENTE



A3 - VERTICALE

cod. 106225 ~ TRASPARENTE



A3 - ORIZZONTALE

cod. 106226 ~ TRASPARENTE



LEAFLET HOLDER ANGLED

PORTA AVVISI INCLINATI

Porta avvisi / messaggi inclinati da banco completamente trasparente. Il messaggio si inserisce facilmente nell'apposita tasca. Realizzato in acrilico trasparente.

- Vari formati disponibili
- Disponibili anche con portadepliant e portabiglietti

Angled leaflet holder, completely transparent. The message fits easily in the pocket. Made from PMMA.

- Many sizes available
- Also with brochure holder and card holder

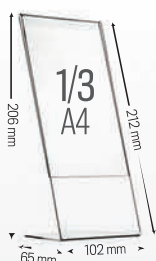
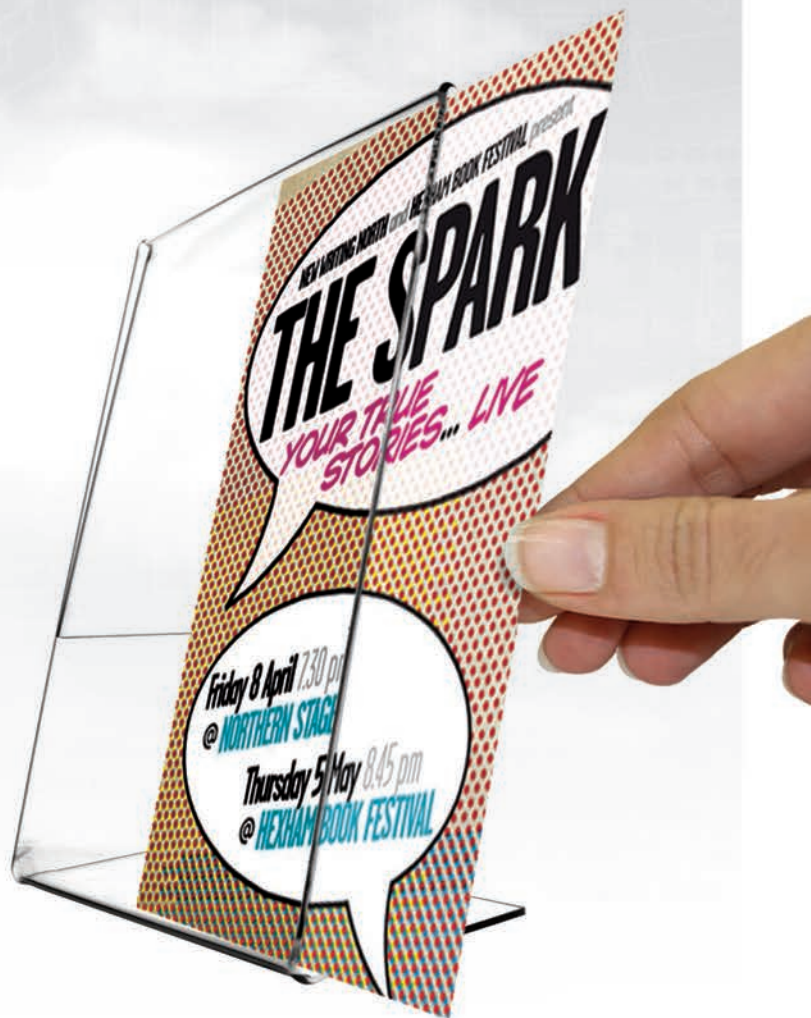

1/3 A4 VERTICALE

cod. 106231 ~ TRASPARENTE

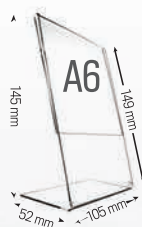

A6 VERTICALE

cod. 106230 ~ TRASPARENTE

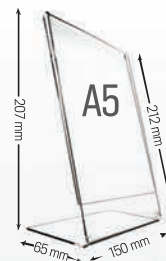

A5 VERTICALE

cod. 106232 ~ TRASPARENTE



A4 VERTICALE

cod. 106233 ~ TRASPARENTE

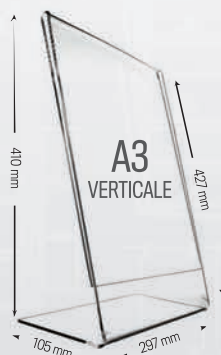

A3 - VERTICALE

cod. 106234 ~ TRASPARENTE

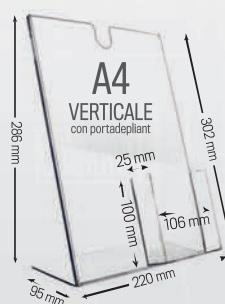

A4 - VERT. + PORTA DEPLIANT

cod. 106235 ~ TRASPARENTE



A4 - VERT. + PORTA BIGLIETTI

cod. 106236 ~ TRASPARENTE



PRICE PORTA AVVISI INCLINATI

Porta avvisi / messaggi inclinati, da banco . Completamente trasparente. Il messaggio si inserisce facilmente nell'apposita tasca. Realizzati in acrilico.

• **Vari formati disponibili**

Small angled leaflet holder, completely transparent. The message fits easily in the pocket. Made from PMMA.

• Many sizes available



PRICE 21076 - 210x76 mm.

cod. 106511 ~ TRASPARENTE

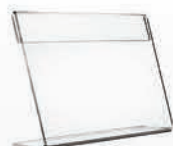
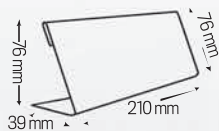

PRICE 150100 - 150x100 mm.

cod. 106512 ~ TRASPARENTE

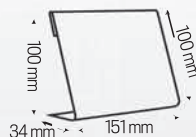

PRICE 11085 - 110x85 mm.

cod. 106514 ~ TRASPARENTE

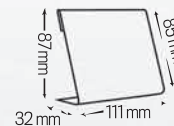

PRICE 10065 - 100x65 mm.

cod. 106515 ~ TRASPARENTE

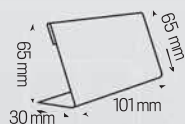

PRICE 8355 - 83x55 mm.

cod. 106516 ~ TRASPARENTE

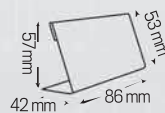



ALUPRICE | PORTA AVVISI INCLINATO

Portavvisi da banco a L. Composti da: base in acciaio e pannello di PMMA trasparente.

- Aggancio magnetico
- Utilizzo verticale e orizzontale

Small leaflet display L. Consisting of: steel base and cover plates of transparent PMMA.

- Magnetic coupling
- Landscape or portrait use

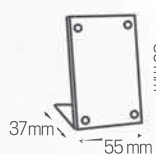

cod. 106521 ~ mm. 55x80



MAGNETIC | PORTA AVVISI MAGNETICO

Portavvisi da banco composti da 2 pannellini di PMMA trasparenti ad aggancio magnetico.

- 3 Dimensioni disponibili
- Utilizzo verticale e orizzontale

Small leaflet holder, consisting of 2 plates of transparent PMMA. Magnetic latching.

- 3 Sizes available
- Landscape or portrait use

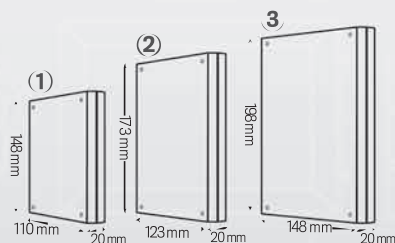

MAGNETIC - TRASPARENTE

- cod. 106251 ~ XK3550 - 110x148 mm (1)
- cod. 106252 ~ XK4060 - 123x173 mm (2)
- cod. 106253 ~ XK5070 - 148x198 mm (3)





DESK LABEL | PORTA AVVISI BIFACCIALI

Cavaliere/segnaposto realizzato in PMMA trasparente. Grazie alla sua forma speciale la stampa all'interno del cavaliere può essere realizzata con una comune stampante e puoi sostituirla quando vuoi. Inserto in carta NON incluso

- Vari formati disponibili

Small leaflet double display. The message fits easily in the pocket. Made from PMMA.

- Many sizes available



DESK LABEL 25080 - 250x80 mm.

cod. 106501 ~ TRASPARENTE

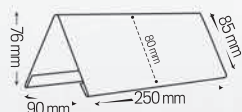

DESK LABEL 200100 - 200x100 mm.

cod. 106502 ~ TRASPARENTE

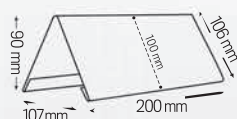

DESK LABEL 20076 - 200x76 mm.

cod. 106503 ~ TRASPARENTE

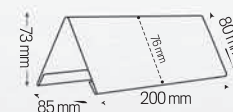

DESK LABEL 18061 - 180x61 mm.

cod. 106504 ~ TRASPARENTE

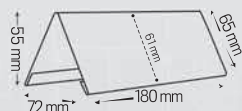

DESK LABEL 15060 - 150x60 mm.

cod. 106505 ~ TRASPARENTE

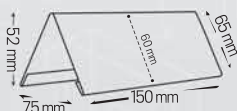

DESK LABEL 12055 - 120x55 mm.

cod. 106506 ~ TRASPARENTE

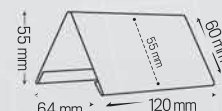

DESK LABEL 5555 - 55x55 mm.

cod. 106507 ~ TRASPARENTE

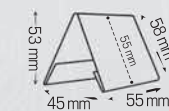



MULTIPLE | PORTA AVVISI MULTIPLO

Portavvisi da banco multiplo con sistema ad anelli. Struttura realizzata in PMMA trasparente. Tasche portafoglio in plastica trasparente.

- 6 Tasche portafoglio A5

Multiple leaflet holder with ring system. Structure made of transparent PMMA. 6 pockets made of clear plastic.

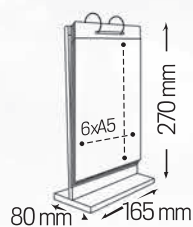

cod. 106242 - 6x A5 - 148x210 mm



PRISMA | PORTA AVVISI 3 FACCIATE

Portavvisi da banco. Realizzato in PMMA trasparente. Le stampe a possono essere realizzate con una comune stampante e puoi sostituirle quando vuoi. Inserto in carta NON incluso.

- 3 Facciate 1/3 di A4.

3 Sided leaflet holder 1/3 rd A4. Made of PMMA.

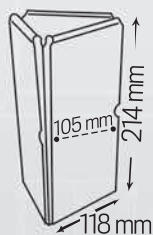

cod. 106241 - 3x - 118x214 mm

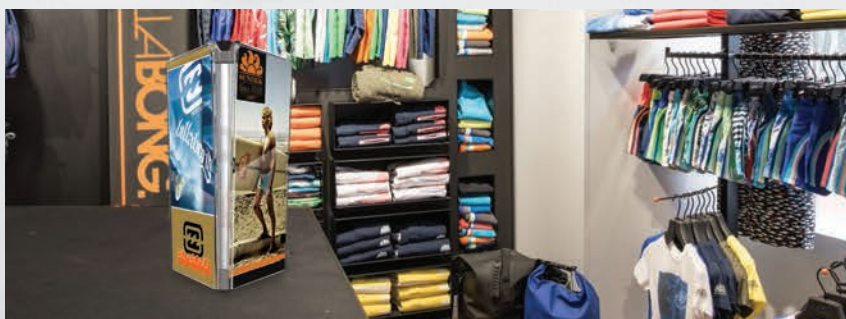



POSTER WINDOW | PORTA AVVISI TRASPARENTI

Utilizzato come porta avvisi o espositore. Grazie alla trasparenza può essere letto da entrambi i lati. Ideale per uffici, aziende e luoghi pubblici in genere. Sostituzione del messaggio semplice e veloce.

- Disponibile A3 - A4 - A5. Verticale e Orizzontale

Clear leaflet display. It can be read from both sides. Available A3 - A4 - A5. Portrait and Landscape. Ideal for offices, businesses and public places. Easy & quick poster change.

- Available A3 - A4 - A5. Portrait and Landscape.

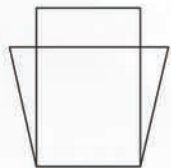

POSTER WINDOW - VERTICALE	
cod. 106247 ~ A3	
cod. 106245 ~ A4	
cod. 106243 ~ A5	

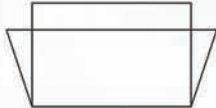

POSTER WINDOW - ORIZZONTALE	
cod. 106248 ~ A3	
cod. 106246 ~ A4	
cod. 106244 ~ A5	



POSTERFIX | PORTA AVVISI TRASPARENTI

Busta portavvisi trasparente. Può essere utilizzato come porta avvisi applicato a pareti, vetrate ed altre superfici. Applicato su targhe o pannelli per creare espositori. Può essere staccato e riapplicato. Montaggio e sostituzione del messaggio semplice e veloce.

- A5 e A4 Orizzontale con bordi Neri
- A3 Verticale con bordi Neri
- A4 Verticale con bordi Neri, Bianchi, Blu, Rossi, Gialli, Verdi e Grigi
- Dotato di adesivo removibile
- Anche con bordi personalizzati

Clear leaflet display with removable adhesive that allows placement on any smooth surface. It can be read from both sides. Easy & quick poster change. Available A5 - A4 - A3.



**POSTERS E MANIFESTI
SENZA UTENSILI
IN MENO DI UN MINUTO**

POSTER FIX - VERTICALE	
cod. 106056 ~ A3 Bordi Neri	
cod. 106054 ~ A4 - Bordi Colorati	

POSTER FIX - ORIZZONTALE	
cod. 106055 ~ A4 Bordi Neri	
cod. 106058 ~ A5 Bordi Neri	





PHONE HOLDER | ESPOSITORE SMARTPHONE *Pos*

Espositore per smartphone con portaprezzo. Realizzato in PMMA trasparente.

- 2 Dimensioni disponibili
- Dotati di portaprezzo
- Pos XL è adatto a Galaxy S8 e simili

Smartphone holder with price holder. Made of transparent PMMA. 2 Sizes available.

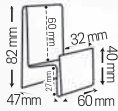

cod. 106530 ~ PHONE HOLDER - POS (1)

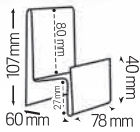

cod. 106528 ~ PHONE HOLDER - POS "XL" (2)



PHONE HOLDER | ESPOSITORE SMARTPHONE *Big*

Espositore per smartphone con porta inserto. Realizzato in PMMA trasparente.

- Può essere applicato su pannello dogato.

Smartphone holder with price holder. Made of transparent PMMA.

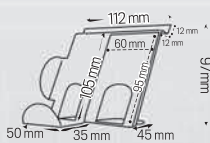

cod. 106529 ~ PHONE HOLDER - BIG





CARD|BOX

Contenitore trasparente, produzione esclusiva Ark Display. Per biglietti da visita, cartoline per alberghi, fiere, ecc. Fessura sulla parte superiore, chiusura laterale in metallo cromato. Realizzato in acrilico trasparente e alluminio.

Clear box, exclusive production Ark Display, used for business cards, cards, holders for fairs, etc. Slot on the top, side closing Chrome. Made clear plastic and aluminum.

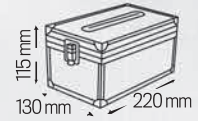

cod. 106531 ~ CARD BOX



SUGGESTION|BOX

Cassetina per suggerimenti. Adatta anche per biglietti da visita, cartoline. Ideale per condomini, alberghi, fiere, ecc. Fessura sulla parte superiore, chiusura con serratura in metallo. Realizzata in plastica e alluminio. Montaggio a parete o su palo. **Dimensioni: 22x29Hx11. cm.**

Suggestion box. Can be used for business cards, suggestion, etc. For palace, hall, hotel, exhibition, etc. Slot on the top, lock. Made of plastic and aluminum. Sizes: 22x29Hx11 cm.

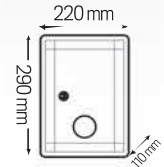
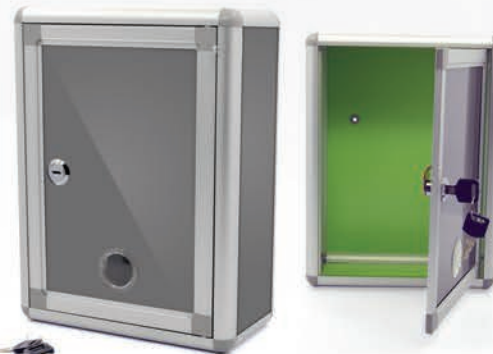

cod. 106621 ~ SUGGESTION BOX



KEYS|BOX

Cassettine portachiavi, realizzate in alluminio. Chiusura magnetica e serratura di sicurezza. Ideale per garage, ~ strutture alberghiere, complessi fieristici, ecc. **Disponibili 6 formati: da 24, 32, 48, 72, 96 e 120 chiavi**

keyring box, made of aluminum. Security lock closure. Ideal for garages, hotels, exhibition centers, etc. Available for 24, 32, 48, 72, 96 and 120 keys. Keyring included.



cod. 106631 ~ KEYS BOX 24 - 22x32,5Hx5,5

cod. 106632 ~ KEYS BOX 32 - 27x32,5Hx5,5

cod. 106633 ~ KEYS BOX 48 - 27x47,5Hx5,5

cod. 106634 ~ KEYS BOX 72 - 40x47,5Hx5,5

cod. 106635 ~ KEYS BOX 96 - 40x63,5Hx5,5

cod. 106636 ~ KEYS BOX 120 - 40x78,5Hx5,5



PRICE | CLIP

Portaprezzi, portafoto, realizzati in plastica traslucida, acciaio e clip in metallo.

- Dimensioni 4,5x11x0,7 cm
- Disponibili 4 colori.

Price holder, made of translucent plastic, steel and metal clip. Sizes: 4,5x11x0,7 cm. 4 colors available.

PRICE CLIP	
①	cod. 106522 - BLU
②	cod. 106523 - BIANCO
③	cod. 106524 - ROSSO
④	cod. 106525 - VERDE



FOLLOW ME | PALETTA TURISTI

Paletta di segnalazione, ideale per guide turistiche o per comitive in viaggio. Composta da palo in metallo cromato e traverso in plastica con binario. Nel binario va aggiunta la personalizzazione che va fatta su pannellino leggero, cartone o simili.

- Supporto per personalizzazione NON incluso

Follow me, ideal for tourist guides or for groups traveling. It consist of chromed metal pole and plastic beam with track. Should be added customization made of a lightweight panel, cardboard or similar.

- Support for customization NOT included

cod. 105104 - FOLLOW ME

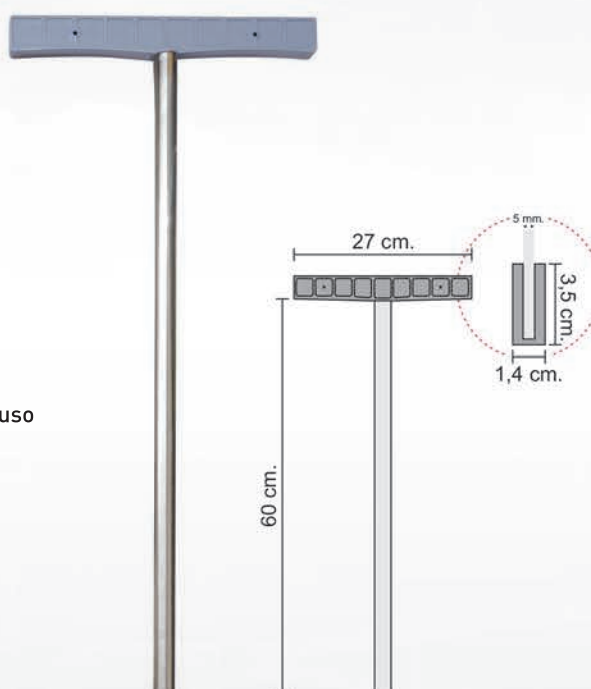

ALUBC | HOLDER

Porta biglietti da visita in alluminio. Per portare con te i biglietti da visita senza rovinarli. Contiene circa 15/20 b.v.

- Dimensioni: 9,2x6x0,7 cm.
- Colore Silver

Busine card holder, made of aluminium. Contains about 15/20 b.c. Colour Silver. Sizes: 9,2x6x0,7 cm.

cod. 106045 - ALU B.C. HOLDER





TABELLE STRADALI ROAD SIGN

Supporti per segnali stradali semilavorati. Sgrassate e verniciate a polvere, colore grigio. Si ossidano leggermente solo nelle giunture dopo 12 mesi. Sul retro gli attacchi per le staffe da agganciare a palo.

- Lamiera 10/10
- Staffe e bulloni non inclusi
- Possibilità di personalizzazione (anche rifrangente)



TABELLE STRADALI - CLASSICHE

cod. **910004** ~ 20x60 - 2 ATTACCHI

cod. **910009** ~ 20x100 - 4 ATTACCHI

cod. **910006** ~ 25x100 - 2 ATTACCHI

cod. **910008** ~ 25x80 - 2 ATTACCHI

cod. **910010** ~ 25x125 - 4 ATTACCHI

cod. **910012** ~ 40x40 - 2 ATTACCHI

cod. **910013** ~ 40x60 - 4 ATTACCHI

cod. **910014** ~ 60x60 - 2 ATTACCHI

cod. **910015** ~ 60x90 - 4 ATTACCHI



TABELLE STRADALI - CIRCOLARI

cod. **910041** ~ Ø 40 - 2 ATTACCHI

cod. **910042** ~ Ø 60 - 2 ATTACCHI

cod. **910043** ~ Ø 60 - 8 ATTACCHI

cod. **910044** ~ Ø 90 - 2 ATTACCHI



TABELLE STRADALI - TRIANGOLARI

cod. **910031** ~ LATO 60 - 2 ATTACCHI

cod. **910032** ~ LATO 90 - 2 ATTACCHI

cod. **910033** ~ LATO 120 - 2 ATTACCHI



TABELLE STRADALI - FRECCE

cod. **910061** ~ 30x130 - 2 CANALINE

cod. **910062** ~ 40x150 - 2 CANALINE



TABELLE STRADALI - OTTAGONALI

cod. **910051** ~ Ø 60 - 2 ATTACCHI

cod. **910052** ~ Ø 90 - 2 ATTACCHI



PALO ZINCATO

Palo zincato per segnaletica esterna/stradale.

Altezza: 3 mt. - Diametro: 60 mm.

Galvanized pole for outdoor/road signage.

Height: 3 meters. - Diameter: 60 mm.

cod. **910071** ~ H 3 mt - Ø 60 mm



STAFFA MONOFACCIALE

Staffa monofacciale per segnaletica esterna/stradale. 2 bulloni inclusi. Sided bracket for out door/road signage. 2 bolts included.

cod. **910081** ~ Ø 60 mm

cod. **910082** ~ Ø 90 mm



STAFFA BIFACCIALE

Staffa bifacciale per segnaletica esterna/stradale. 4 bulloni inclusi. Double sided bracket for out door/road signage. 4 bolts included.

cod. **910083** ~ Ø 60 mm



BASE MOBILE PER PALI

Base mobile per pali di diametro 60 mm. Altezza Centro: 15 cm. - Diametro: 60 cm. - Colore: Nero.

Base for pole Ø 60 mm. - Center Height: 15 cm - Diameter: 60 cm. Colour: Black

cod. **910072** ~ PER PALI DA Ø 60 mm

ACCESSORIES & TOOLS



Accessori e piccoli utensili per realizzare le vostre esposizioni



Accessories and tools to realize your exhibition



HELLO | PORTA NOME

Portanome realizzati in alluminio. Comprensivi di spilla e clip.

- 2 Colori: Blu e Argento
- Dimensioni cm. 7x2,5x0,4.
- Inserto cm 7x1

Name tag holder, made of aluminium. With pins. 2 Colours Blue and Silver. Sizes: cm. 7x2,5x0,4 - Insert: cm. 7x1



HELLO ~ PORTANOME

cod. 106603 ~ HELLO - BLU

cod. 106610 ~ HELLO - ARGENTO



WHO ARE YOU | PORTA BADGE

Porta badge realizzati in PVC trasparente. Disponibili con clip nichelata e con nastrino.

- 3 formati disponibili
- Cartoncino neutro incluso.

Badge holder, made of clear PVC. Available 3 sizes, nickel-plated clip end ribbon. Cardboard Included.



PORTABADGE WHO ARE YOU

① cod. 106604 ~ 9,5x8 cm. - Clip

② cod. 106605 ~ 12,7x9,3 cm. - Clip + Nastro

③ cod. 106606 ~ 9,3x12,5 cm. - Clip + Nastro



STRING | CORDONCINO PORTABADGE

Cordoncino da collo in poliester con gancio in metallo cromato.

- Dimensioni 82x2 cm. ca.
- 11 Colori disponibili.

Necklace made of polyester with metal hook. Size 82x2 cm. ca. 11 colors available.



cod. 106607 ~ PVC BADGE - 10x9



cod. 106608 ~ PVC BADGE - 11x9,5

cod. 106609 ~ PVC BADGE - 8,4x12,1

STRING - CORDONCINO PORTABADGE

cod. 800006 ~ GIALLO

cod. 800001 ~ ARANCIO

cod. 800008 ~ NERO

cod. 800002 ~ AZZURRO

cod. 800009 ~ ROSSO

cod. 800003 ~ BIANCO

cod. 800010 ~ ROSA

cod. 800004 ~ BLU

cod. 800011 ~ ROYAL BLUE

cod. 800005 ~ FUCSIA

cod. 800012 ~ VERDE



MEETING BANDS

Braccialetti monouso identificativi. Resistenti, impermeabili e anallergici. Dotati di chiusura antieffrazione. Disponibili in tanti colori per favorire la gestione ed il controllo degli accessi. Ideali per fiere, congressi, seminari, conferenze stampa, ecc. Disponibili in Tyvek, PVC e Carta Laminata. Su richiesta è possibile fornire anche il prodotto personalizzato.

Disposable identification wristbands. Resistant, waterproof and hypoallergenic. unbreakable closing. Available in many colors to facilitate the management and control of the accesses. Ideal for trade shows, conferences, seminars, press conferences, etc. Available in Tyvek, PVC and laminated paper. On request we can also provide printed product.



TYVEK

- Originali DU PONT
- Materiale simile alla carta laminata
- 10 colori disponibili
- Chiusura adesiva antieffrazione
- Dimensione 1,8x25,4 cm.
- Doppia numerazione



cod. 40001 ~ TYVEK - ARANCIO	cod. 40007 ~ TYVEK - NERO
cod. 40002 ~ TYVEK - BIANCO	cod. 40008 ~ TYVEK - ROSSO
cod. 40003 ~ TYVEK - BLU	cod. 40009 ~ TYVEK - VERDE
cod. 40004 ~ TYVEK - GIALLO	cod. 40010 ~ TYVEK - VIOLA
cod. 40005 ~ TYVEK - FLUO LIME	cod. 40013 ~ TYVEK - ORO
cod. 40006 ~ TYVEK - FLUO ROSA	cod. 40014 ~ TYVEK - ARGENTO

PRODOTTI NEUTRI SENZA STAMPA

PVC

- Morbidi al tatto
- 4 finiture e tanti colori disponibili
- Chiusura con bottone antieffrazione
- Dimensione 1,5x25 cm.



PVC SOLID

cod. 40510 ~ SOLID - ARANCIO	cod. 40515 ~ SOLID - AZZURRO	cod. 40521 ~ SOLID - ORO
cod. 40511 ~ SOLID - VERDE	cod. 40516 ~ SOLID - BLU NAVY	cod. 40522 ~ SOLID - NERO
cod. 40512 ~ SOLID - GIALLO	cod. 40518 ~ SOLID - FUCSIA	PRODOTTI NEUTRI SENZA STAMPA
cod. 40513 ~ SOLID - BABY PINK	cod. 40519 ~ SOLID - VIOLA	
cod. 40514 ~ SOLID - TRASPARENTE	cod. 40520 ~ SOLID - ARGENTO	

PVC NEON - FLUO (FORTE E VIVACE)

cod. 40501 ~ NEON - VIOLA	cod. 40505 ~ NEON - ARANCIO
cod. 40502 ~ NEON - BLU	cod. 40506 ~ NEON - ROSSO
cod. 40503 ~ NEON - GIALLO	cod. 40507 ~ NEON - FLUO VERDE
cod. 40504 ~ NEON - ROSA	PRODOTTI NEUTRI SENZA STAMPA

PVC GLITTER - FINITURA GLITTERATA

cod. 40523 ~ GLITTER - BIANCO	cod. 40527 ~ GLITTER - VERDE
cod. 40524 ~ GLITTER - NERO	cod. 40528 ~ GLITTER - ORO
cod. 40525 ~ GLITTER - ROSSO	cod. 40529 ~ GLITTER - ARANCIO
cod. 40526 ~ GLITTER - BLU	PRODOTTI NEUTRI SENZA STAMPA

PVC PEARL - FINITURA PERLATA

cod. 40508 ~ PEARL - BLU
cod. 40509 ~ PEARL - VERDE
PRODOTTI NEUTRI SENZA STAMPA

CARTA LAMINATA

- Stampa digitale immediata
- Personalizzabili con Stampante Laser
- Qualità Fotografica
- Fogli da 10 pz. prefustellati
- Chiusura adesiva antieffrazione
- Dimensione 1,9x25,5 cm.



1 FOGLIO DA 10 pz.
cod. 40011 - CARTA LAMINATA
PRODOTTO NEUTRO SENZA STAMPA



OCCHIELLATRICE PROFESSIONAL

Perfetta per occhiellare banner e striscioni. In un solo colpo fora il materiale e chiude l'occhiello. Possibilità di cambiare la matrice nel caso di utilizzo di occhielli di diverse dimensioni.

- Realizzata in ghisa
- Matrici/Punzoni intercambiabili
- Base: 250x95 mm. Spessore 25 mm.
- Altezza (manico compreso): 510 mm.
- Peso: Kg. 8,20

Professional machine with Interchangeable Dies, meets all your different needs. Self piercing: cuts a hole and sets an eyelet simultaneously. Easy To Use - Made of cast iron.

cod. 50121 - OCCHIELLATRICE PROFESSIONAL

PUNZONI ~ OCCH. PROFESSIONAL



cod. 50126 ~ ID 6
PER OCCHIELLI CON
DIAMETRO INTERNO 6 mm



cod. 50127 ~ ID 8
PER OCCHIELLI CON
DIAMETRO INTERNO 8 mm



cod. 50128 ~ ID 10
PER OCCHIELLI CON
DIAMETRO INTERNO 10 mm



cod. 50125 ~ ID 12
PER OCCHIELLI CON
DIAMETRO INTERNO 12 mm



cod. 50129 ~ ID 13,5
PER OCCHIELLI CON
DIAMETRO INTERNO 13,5 mm



cod. 50130 ~ ID 15
PER OCCHIELLI CON
DIAMETRO INTERNO 15 mm

DISPONIBILI OCCHIELLI
PER TUTTI I PUNZONI



OCCHIELLATRICE SEMI AUTOMATICA

In un solo colpo fora il materiale e chiude l'occhiello. Gli occhielli, nel vano, vengono caricati nel piedino in modo automatico per essere applicati in rapida successione. Punzonatura assistita. Funziona con appositi occhielli speciali ID 10 mm.

- Ruote sulla base per gli spostamenti
- Base: 300x340 mm
- Altezza (manico compreso): 600 mm.

Which pierces your material while it automatically feeds and sets the grommet. Wheels at the bottom to move it easily. Easy to use. Use special eyelets ID 10

cod. 50136 - OCCHIELLATRICE SEMI-AUTO



cod. 50137 ~ ID 10
PER OCCHIELLATRICE
SEMI AUTOMATICA - 5000 PZ.



OCCHIELLATRICE MANUALE "EASY"

Occhiellatrice portatile per banner e striscioni. Utilizza appositi occhielli speciali "ID 10 EASY" Smart eyelet puncher, easy to carry. Easy to use. Use special eyelets ID 10 Ariotech.

cod. 50123 - OCCHIELLATRICE EASY



cod. 50124 ~ ID 10
PER OCCHIELLATRICE EASY
500 PZ.



ARROTONDA ANGOLI PROFESSIONAL

Perfetta per arrotondare card, biglietti da visita, menu, inviti, plastiche e forex di piccolo spessore. Con gli accessori è possibile realizzare il taglio lunetta per i calendari. Fornita con lama intercambiabile da 6 mm. di raggio.

- Macchina a lame intercambiabili
- Cambio lama semplice e veloce
- Cassetto raccogli truciolo
- Larghezza: mm 227 - Altezza : mm 140
- Profondità: mm 147
- Peso : kg. 2.2

Desktop corner rounding machine, supplied complete with a 6mm round corner cutter. The blades are easily changeable.



cod. 50103 - ARROTONDA ANGOLI PRO

LAME INTERCAMBIABILI - PRO



R3,5
cod. 51104 - R 3,5
LAMA TONDA - RAGGIO 3,5 mm

R10
cod. 51105 - R 10
LAMA TONDA - RAGGIO 10 mm

C15
cod. 51106 - C 15
LAMA DRITTA - SMUSSO

D6
cod. 51107 - D 6
LAMA PER FORO - DIAM. 6 mm

PER CALENDARI
D21
cod. 51108 - D 21
LAMA LUNETTA - DIAM. 21 mm

cod. 51110 - PAD
FERMABATTUTA - 5 PZ.

cod. 51109 - ID 6
GUIDA FERMAFOGLIO REGOLABILE



ARROTONDA ANGOLI EASY

La soluzione più economica ed efficace per la tua agenzia di pubblicità. Con l'arrotonda angoli EASY puoi tranquillamente consegnare i biglietti da visita con angolo arrotondato. Una grande differenza, un piccolo investimento.

- Capacità di taglio 4 fogli ca.
- Lame in acciaio
- 2 varianti disponibili:
Lama "S" raggio 5 mm - Lama "L" raggio 10 mm
- Cassetto raccogli truciolo
- Colori assortiti in base alla disponibilità

For cutting paper, photos, business cards, etc. Using this tool, you can put the photos of 4 right angle turns Round corner. The Round corner is not easy to damage. The bottom of the lid can be opened, very convenient to clean waste paper. Available 2 sizes.

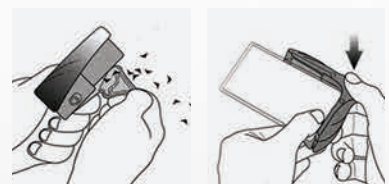

cod. 51101 - LAMA S - Raggio 5 mm

cod. 51102 - LAMA L - Raggio 10 mm



TAGLIERINO SPECIAL

Piccolo e maneggevole. Realizzato in acciaio con impugnatura in plastica. Per il taglio in sicurezza di imballaggi, adesivi, cartone, fascette, cinture di sicurezza. Adatto al taglio di spessori più grandi. Non adatto per tagli di precisione.

- Realizzata in acciaio con impugnatura in plastica
- Per il taglio dei supporti in carta degli adesivi
- 2 formati disponibili
 - 1) SMALL - 12,5x3x1 cm
 - 2) BIG - 16x2x1 cm

Small and handy. Made of steel with plastic handle. An effective blade less tape splitter also safely splits box tape to open boxes.

cod. 50151 - SPECIAL - SMALL

cod. 50152 - SPECIAL - BIG

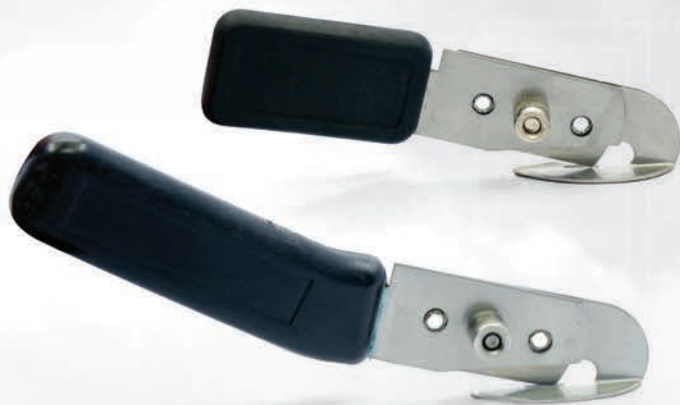

RIGHELLO SAFETY

Righelli antinfortunistici per tagli in sicurezza. Realizzati in alluminio anodizzato. Grazie alla particolare forma, la mano di appoggio è protetta da incidenti di taglio. Dotati di gomma antiscivolo, metro e tondino protettivo in metallo.

- Realizzati in alluminio
- Protezione per la mano d'appoggio
- Sezione: 10,5 x 4,5 cm.
- 4 lunghezze disponibili

Safety rulers have a large metal straightedge of lightweight aluminum with a chrome steel cutting ruler edge. Hands are kept safe by raised finger guard.

cod. 50271 - SAFETY - 80 cm

cod. 50272 - SAFETY - 110 cm

cod. 50273 - SAFETY - 140 cm

cod. 50274 - SAFETY - 170 cm

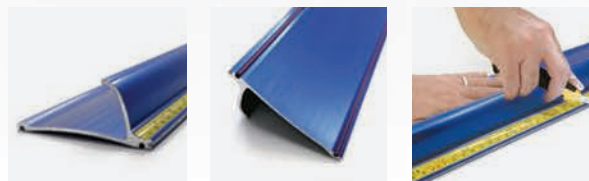

BASI DA TAGLIO

Abbastanza morbida da proteggere la lama e abbastanza rigida da evitare incisioni profonde. Piano da taglio professionale di qualità auto-riparante (torna liscio dopo il passaggio della lama).

- Utilizzabili entrambi i lati
- 3 dimensioni disponibili

The core ensures that light, fine cuts into its surface "heal". It has an alignment grid on one surface. 3 sizes available.

cod. 50490 - A2 - 42x59,4 cm

cod. 50491 - A1 - 59,4x84,1 cm

cod. 50492 - A0 - 84,1x118,9 cm

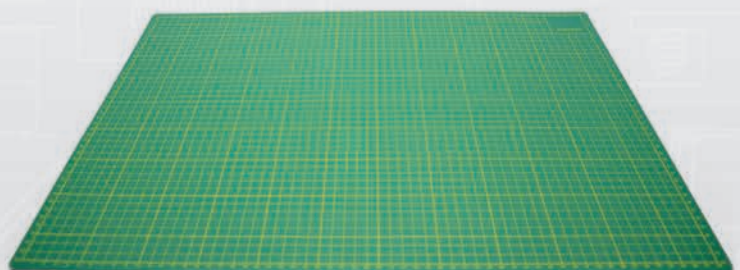



SPATOLA CLASSIC

- Per applicazione adesivo
- 1 lato rigido e l'altro semi-morbido
- Materiale: Plastica - Colore: Blu
- Dimensioni: 10x7 cm.

cod. 50601 - SPATOLA CLASSIC



SPATOLA CON NEOPRENE - FELTRO 1 mm.

- Per applicazione adesivo e grafiche
- Fascia in Neoprene o Feltro antigraffio
- Spessore 1 mm.
- Materiale: Plastica - Colore: Blu
- Dimensioni: 10x7 cm.

cod. 50631 - SPATOLA + NEOPRENE 1 mm.

cod. 50633 - SPATOLA + FELTRO 1 mm.



SPATOLA CON NEOPRENE - FELTRO 2 mm.

- Per applicazione adesivo e grafiche
- Fascia in Neoprene o Feltro antigraffio
- Spessore 2 mm.
- Materiale: Plastica - Colore: Verde
- Dimensioni: 10x7 cm.

cod. 50632 - SPATOLA + NEOPRENE 2 mm.

cod. 50632 - SPATOLA + FELTRO 2 mm.



SPATOLA BIG CON FELTRO

- Per applicazioni su grandi superfici
- Spessore 2 mm.
- Fascia in Feltro nero antigraffio
- Materiale: Plastica - Colore: Verde
- Dimensioni: 14,5x8 cm.

cod. 50651 - SPATOLA BIG CON FELTRO



SPATOLA CURVA CON ROLLER

- Per applicazioni in punti difficili
- Roller in gomma antigraffio
- Materiale: Plastica - Colore: Giallo
- Dimensioni: 12x8 cm.
- Colori Assortiti

cod. 50652 - SPATOLA CURVA / ROLLER



SPATOLE FELTRO

- Per applicazioni delicate
- Spessore 10 mm. - Lana grado "A"
- Spessore 14 mm. - Lana grado "B"
- Materiale: Lana Australiana
- Dimensioni: 10x7 cm.

cod. 50621 - SPATOLA FELTRO 10 mm.

cod. 50622 - SPATOLA FELTRO 14 mm.



SPATOLA MAGNETICA

- Per applicazione adesivo
- Con magneti all'interno
- Materiale: Plastica - Colori: Assortiti
- Dimensioni: 10x7 cm.

cod. 50654 - SPATOLA MAGNETICA



SPATOLA FELTRO CON MANICO

- Per applicazione adesivo
- Impugnatura in plastica blu
- Feltro Spessore 10 mm.

cod. 50655 - FELTRO CON MANICO



SPATOLINA PLASTICA

- In plastica rigida
- Ridotte dimensioni e facile impugnatura
- Colore Giallo
- Utilizzo anche come raschietto

cod. 50659 - SPATOLINA PLASTICA



SPATOLA GOMMA

- Per applicazione adesivo
- Spatola in gomma morbida
- Impugnatura in plastica
- Colore Giallo

cod. 50660 - SPATOLA IN GOMMA



SPATOLA GRANDE CON MANICO

- Spatola in gomma morbida
- Lunghezza 30 cm
- Impugnatura ergonomica
- Applicazione adesivi di grande formato

cod. 50656 - GRANDE CON MANICO



SPATOLA SEMICIRCOLARE

- Per applicazioni su superfici curve
- Forma semi-circolare
- Materiale: Plastica - Colore: Bianco
- Dimensioni Maxi 15,5x10,5 cm.

cod. 50653 - SPATOLA SEMICIRCOLARE

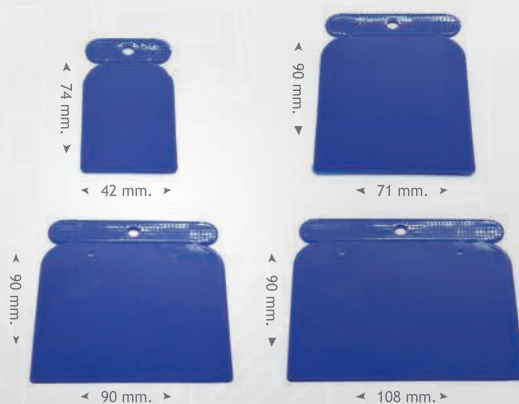

SPATOLE KIT-X4

- Set di 4 spatole di varie dimensioni
- Per lavori su diverse grandezze
- Spessore 2 mm. (tutte)
- Dotate di impugnatura
- Materiale: Plastica - Colore: Blu

cod. 50663 - SPATOLE KIT-X4



FERMA ROTOLO

- Per bloccare i rotoli di vinile senza l'utilizzo di adesivi
- Tipo 1) LOOP in plastica elastica
- 2 Misure disponibili: Ø 12 cm - Ø 8 cm -
- Tipo 2) RING in plastica con molla in ferro e anello per etichette. Ø 12 cm

- cod. 50790 ~ LOOP Ø 12 cm ①
- cod. 50792 ~ LOOP Ø 8 cm ①
- cod. 50791 ~ RING Ø 12 cm ②



TENDI TELO

- Sistema di tensionamento per banner
- Riutilizzabili e facili da utilizzare
- Lunghezza 16 cm. ca.
- Disponibili con sfera o con gancio

- cod. 50701 ~ TENDITELO SFERA ①
- cod. 50705 ~ TENDITELO GANCIO ②



OCCHIELLI NO-HOLE

- Pratiche pinze/occhiali
- Si applicano senza forare il materiale
- Riutilizzabili e facili da utilizzare
- Adatti per utilizzo esterno
- Disponibili 2 tipologie

- cod. 50711 ~ NO-HOLE NERO ①
- cod. 50710 ~ NO-HOLE BIANCO ②



① 7,2x4 cm. ca - Foro 0,8 cm. ca.

② 4,7x3,5 cm. ca - Foro 0,8 cm. ca.



MAGNETE SUPER POTENTE

- Per applicazione adesivo - car wrapping
- 1) Diametro 43 mm - Spessore 6 mm - Altezza: 63 mm
- 2) Diametro 65 mm - Spessore 8 mm - Altezza: 90 mm
- 3) Diametro 88 mm - Spessore 8,5 mm - Altezza: 92 mm

- cod. 50795 ~ MAGNETE 43 mm ①
- cod. 50796 ~ MAGNETE 65 mm ②
- cod. 50797 ~ MAGNETE 88 mm ③



MAGNETIC STRIP

NASTRO MAGNETICO CON BIADESIVO

- Nastro strip magnetico
- Biadesivo incluso, già applicato
- Tipo 398: 12,7 mm. x 30 mt.
- Tipo 400: 15 mm. x 30 mt. (Ariotech)



MAGNETIC STRIP

- cod. 103510 ~ 398 - 12,7 mm x 30 mt.
- cod. 103521 ~ 400 - 15 mm x 30 mt.



FASCE ELASTICHE

Trovano grande utilizzo impiegate con i banner E tessuti. Con le fasce più spesse si realizzano le asole per bandiere a goccia e classic flag. nei colori Nero e Bianco

- Rotoli da 10 mt.
- Tante larghezze disponibili
- Colori disponibili Nero e Bianco

Elastic bands, high quality. Can be used for textile banner. Available many sizes. Colours: Black and White.

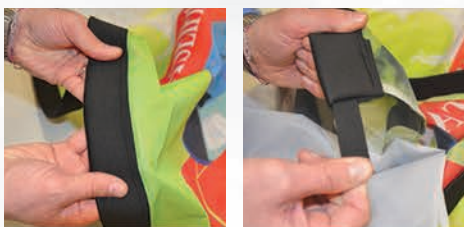

FASCIA ELASTICA~ 15 mm		FASCIA ELASTICA~ 20 mm		FASCIA ELASTICA~ 25 mm		FASCIA ELASTICA~ 30 mm							
cod. 52101 ~ 15 mm - BIANCA	cod. 52102 ~ 15 mm - NERA	cod. 52103 ~ 20 mm - BIANCA	cod. 52104 ~ 20 mm - NERA	cod. 52105 ~ 25 mm - BIANCA	cod. 52106 ~ 25 mm - NERA	cod. 52107 ~ 30 mm - BIANCA	cod. 52108 ~ 30 mm - NERA						
FASCIA ELASTICA~ 35 mm		FASCIA ELASTICA~ 40 mm		FASCIA ELASTICA~ 50 mm		FASCIA ELASTICA~ 60 mm		FASCIA ELASTICA~ 80 mm		FASCIA ELASTICA~ 100 mm		FASCIA ELASTICA~ 120 mm	
cod. 52109 ~ 35 mm - BIANCA	cod. 52110 ~ 35 mm - NERA	cod. 52111 ~ 40 mm - BIANCA	cod. 52112 ~ 40 mm - NERA	cod. 52113 ~ 50 mm - BIANCA	cod. 52114 ~ 50 mm - NERA	cod. 52115 ~ 60 mm - BIANCA	cod. 52116 ~ 60 mm - NERA	cod. 52117 ~ 80 mm - BIANCA	cod. 52118 ~ 80 mm - NERA	cod. 52119 ~ 100 mm - BIANCA	cod. 52120 ~ 100 mm - NERA	cod. 52121 ~ 120 mm - BIANCA	cod. 52122 ~ 120 mm - NERA



VELCRO ADESIVO

Velcro con adesivo. Uncino (maschio) e Asola (femmina). Rotoli da 25 metri. 3 larghezze disponibili, nei colori Nero e Bianco

- Uncino (maschio) e Asola (femmina) sono venduti separatamente
- Rotoli da 25 mt.
- Larghezze disponibili 20,30 e 50 mm
- Colori disponibili Nero e Bianco

Complete adhesive velcro, male and female. Available many sizes. Colour: black and white.

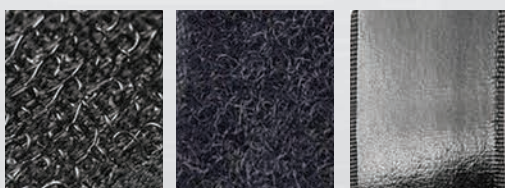

UNCINO (MASCHIO) ~ 20 mm		UNCINO (MASCHIO) ~ 30 mm		UNCINO (MASCHIO) ~ 50 mm		
cod. 52011 ~ 20 mm - BIANCO	cod. 52013 ~ 20 mm - NERO	cod. 52021 ~ 30 mm - BIANCO	cod. 52023 ~ 30 mm - NERO	cod. 52031 ~ 50 mm - BIANCO	cod. 52033 ~ 50 mm - NERO	
ASOLA (FEMMINA) ~ 20 mm		ASOLA (FEMMINA) ~ 30 mm		ASOLA (FEMMINA) ~ 50 mm		
cod. 52012 ~ 20 mm - BIANCO	cod. 52014 ~ 20 mm - NERO	cod. 52022 ~ 30 mm - BIANCO	cod. 52024 ~ 30 mm - NERO	cod. 52032 ~ 50 mm - BIANCO	cod. 52034 ~ 50 mm - NERO	

Note:

.....

.....

.....

.....

.....

Note:

.....

.....

.....

.....

.....

Note:

.....

.....

.....

.....

.....

Note:

.....

.....

.....

.....

.....

Note:

.....

.....

.....

.....

.....

Note:

.....

.....

.....

.....

.....

Note:

.....

.....

.....

.....

.....

Note:

.....

.....

.....

.....

.....

Note:

.....

.....

.....

.....

.....

Note:

.....

.....

.....

.....

.....





**LOOK BEYOND
WHAT YOU SEE** **19**
TWO THOUSAND
eighteen

